



THE VINEYARD ESTATES

Cabernet

Interior Package

HERZOG ESTATES - LOT 15

PROJECT ADDRESS: 2955 HERZOG DR.
PETALUMA, CA

INTERIOR DESIGNER: ELYSSA CONTARDO DESIGNS
73160 EL PASEO, STE. 6
PALM DESERT, CA 92260

ELYSSA CONTARDO
P// 760.579.8113
E// ELYSSA@ELYSSACONTARDO.COM

BUILDER: BUILTY BY DOTTO CONSTRUCTION
DOMINIC DOTTO
P// 415.785.8703



SHEET INDEX

T	TITLE SHEET	
EXR-1	EXTERIOR RENDERINGS	I-11
EXR-1.1	EXTERIOR RENDERINGS	I-11.1
IR-1	INTERIOR RENDERINGS	
FP-1	PROPERTY FLOOR PLAN	I-12
FP-1.1	MAIN LEVEL FLOOR PLAN	I-12.1
FP-1.2	UPPER LEVEL FLOOR PLAN	I-12.1
FS	FLOOR SCHEME	
FP-2	FLOOR PLAN - FLOOR FINISHES	I-13
FP-3	FLOOR PLAN - CEILING FINISHES	I-13.1
FP-4	FLOOR PLAN - WALL FINISHES	
RCP-1	REFLECTED CEILING PLAN	I-14
CP-2	CEILING PLAN	I-14.1
	KITCHEN MATERIALS SHEET	
I-1	KITCHEN ELEVATIONS	I-15
I-1.1	KITCHEN 3D RENDERING	I-15.1
	BUTLER'S PANTRY MATERIALS SHEET	
	BUTLER'S PANTRY ELEVATIONS	I-16
	BUTLER'S PANTRY 3D RENDERING	I-16.1
	GREAT ROOM BAR MATERIALS SHEET	
I-2	GREAT ROOM BAR ELEVATIONS	I-16.1
I-2.1	GREAT ROOM BAR 3D RENDERING	I-17
		I-17.1
		I-18
I-3	GREAT ROOM BAR ELEVATIONS	I-18.1
I-3.1	GREAT ROOM BAR 3D RENDERING	I-19
	POWDER MATERIALS SHEET	I-19.1
I-4	POWDER ELEVATIONS	I-20
I-4.1	POWDER 3D RENDERING	I-20.1
		I-21
	LAUNDRY MATERIALS SHEET	I-21.1
I-5	LAUNDRY ELEVATIONS	I-22
I-5.1	LAUNDRY 3D RENDERING	I-22.1
		I-23
	BATH 3 MATERIALS SHEET	I-23.1
I-6	BATH 3 ELEVATIONS	I-24
I-6.1	BATH 3 3D RENDERING	I-24.1
	SHARED BATH 1 & 2 MATERIALS SHEET	I-25
I-7	SHARED BATH 1 & 2 ELEVATIONS	I-25.1
I-7.1	SHARED BATH 1 & 2 3D RENDERING	I-26
	PRIMARY BATH MATERIALS SHEET	I-26.1
I-8	PRIMARY BATH ELEVATIONS	I-27
I-8.1	PRIMARY BATH 3D RENDERING	I-27.1
	POOL HOUSE POWDER MATERIALS SHEET	
I-9	POOL HOUSE POWDER ELEVATIONS	
I-9.1	POOL HOUSE POWDER 3D RENDERING	
	POOL HOUSE KITCHENETTE MATERIALS SHEET	
I-10	POOL HOUSE KITCHENETTE ELEVATIONS	
I-10.1	POOL HOUSE KITCHENETTE 3D RENDERING	
	POOL HOUSE BATH MATERIALS SHEET	
	POOL HOUSE BATH ELEVATIONS	
	POOL HOUSE BATH 3D RENDERING	
	OUTDOOR BATH MATERIALS SHEET	
	OUTDOOR BATH ELEVATIONS	
	OUTDOOR BATH 3D RENDERING	
	OUTDOOR KITCHEN MATERIALS SHEET	
	OUTDOOR KITCHEN ELEVATIONS	
	OUTDOOR KITCHEN 3D RENDERING	
	WINE ROOM MATERIALS SHEET	
	WINE ROOM ELEVATIONS	
	WINE ROOM 3D RENDERING	
	PRIMARY BEDROOM WET BAR MATERIALS SHEET	
	PRIMARY BEDROOM ELEVATIONS	
	PRIMARY BEDROOM 3D RENDERING	
	DINING ROOM BUILT-IN BENCH ELEVATIONS	
	DINING ROOM BUILT-IN BENCH 3D RENDERING	
	ENTRY MUDROOM ELEVATIONS	
	ENTRY MUDROOM 3D RENDERING	
	ADU CLOSET ELEVATIONS	
	ADU CLOSET 3D RENDERING	
	ADU LAUNDRY ELEVATIONS	
	ADU LAUNDRY 3D RENDERING	
	ADU BEDROOM CLOSET ELEVATIONS	
	ADU BEDROOM CLOSET 3D RENDERING	
	REC ROOM TV BUILT-IN ELEVATIONS	
	REC ROOM TV BUILT-IN 3D RENDERING	
	REC ROOM CLOSET ELEVATIONS	
	REC ROOM CLOSET 3D RENDERING	
	BEDROOM 1 WALK-IN CLOSET ELEVATIONS	
	BEDROOM 1 WALK-IN CLOSET 3D RENDERING	
	BEDROOM 2 & 3 CLOSETS ELEVATIONS	
	BEDROOM 2 & 3 CLOSETS 3D RENDERING	
	LIBRARY ELEVATIONS	
	LIBRARY 3D RENDERING	
	OFFICE ELEVATIONS	
	OFFICE 3D RENDERING	
	FAMILY ROOM SHELVES ELEVATIONS	
	FAMILY ROOM SHELVES 3D RENDERING	



ELYSSA CONTARDO DESIGNS
P// 760.579.8113
ELYSSA@ELYSSACONTARDO.COM

GENERAL NOTES:
WRITTEN DIMENSIONS SHALL TAKE PRECEDENCE OVER SCALED DIMENSIONS AND SHALL BE VERIFIED ON JOB SITE. ANY DISCREPANCY SHALL BE BROUGHT TO THE ATTENTION OF ELYSSA CONTARDO DESIGNS FOR CLARIFICATION BEFORE PROCEEDING WITH WORK. DRAWINGS TO BE USED IN CONSTRUCTION WITH ARCHITECT DRAWINGS. ALL DIMENSIONS ARE BASED ON ARCHITECTURAL DRAWINGS. AS-BUILT CONDITIONS MAY VARY.

DRAWING:
PROJECT:
2955 HERZOG DR., PETALUMA, CA

REVISIONS	DESCRIPTION

SQ. FOOTAGE:
INTERIOR: -
EXTERIOR: -
TOTAL: -

DATE:
1-7-2025
SCALE:
NTS

SHEET:
1



ELYSSA CONTARDO DESIGNS
P// 760.579.8113
ELYSSA@ELYSSACONTARDO.COM

GENERAL NOTES
WRITTEN DIMENSIONS SHALL TAKE PRECEDENCE OVER SCALED DIMENSIONS AND SHALL BE VERIFIED ON JOB SITE. ANY DISCREPANCY SHALL BE BROUGHT TO THE ATTENTION OF ELYSSA CONTARDO DESIGNS FOR CLARIFICATION BEFORE PROCEEDING WITH WORK. DRAWINGS TO BE USED IN CONNECTION WITH ARCHITECT DRAWINGS. ALL DIMENSIONS ARE BASED ON ARCHITECTURAL DRAWINGS. AS BUILT CONDITIONS MAY VARY.

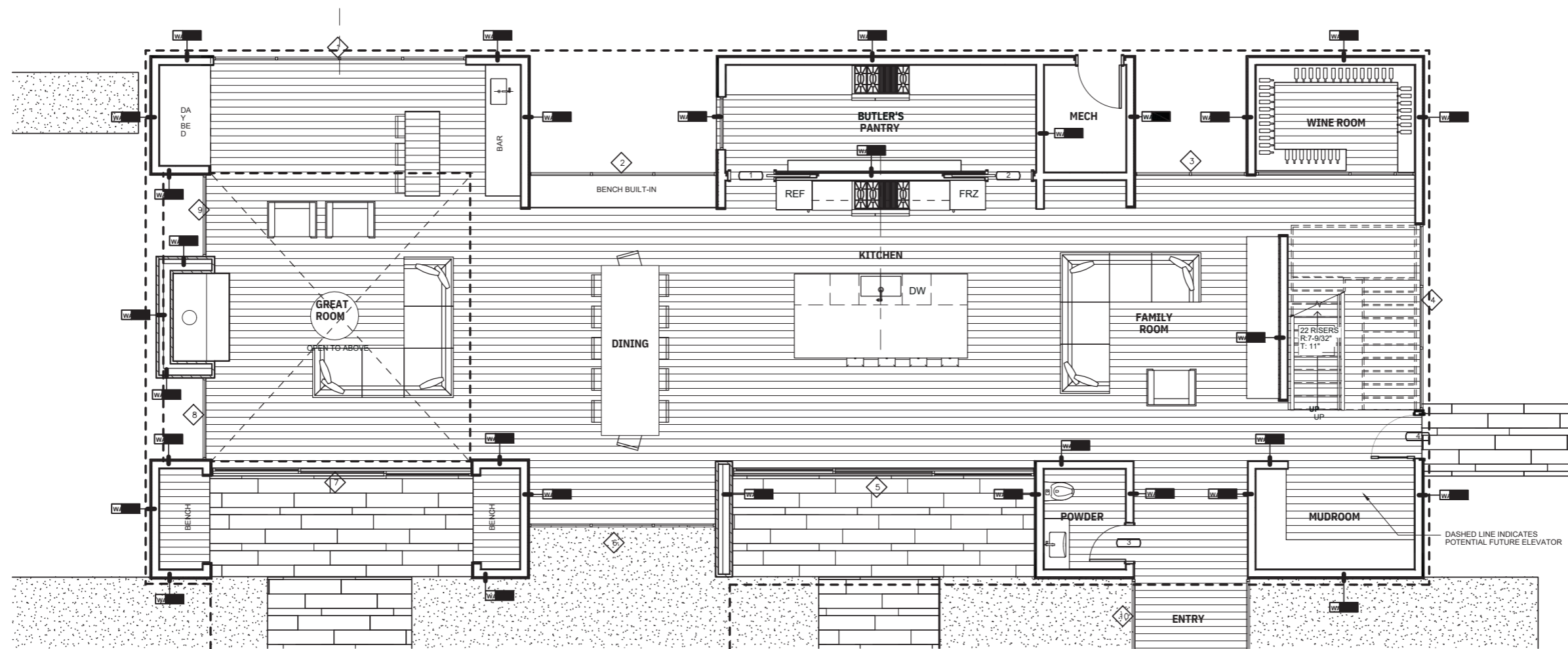

PROJECT:

DRAWING:

REVISIONS DESCRIPTION

REVISIONS	DESCRIPTION

SQ. FOOTAGE:
INTERIOR: -
EXTERIOR: -
TOTAL: -

DATE:
3-28-25
SCALE:
NTS
SHEET:

FP-1.1

MAIN LEVEL FLOOR PLAN



ELYSSA CONTARDO DESIGNS
 P// 760.579.8113
 ELYSSA@ELYSSACONTARDO.COM

GENERAL NOTES:
 WRITTEN DIMENSIONS SHALL TAKE PRECEDENCE OVER SCALED DIMENSIONS AND SHALL BE VERIFIED ON JOB SITE. ANY DISCREPANCY SHALL BE BROUGHT TO THE ATTENTION OF ELYSSA CONTARDO DESIGNS FOR CLARIFICATION BEFORE PROCEEDING WITH WORK. DRAWINGS TO BE USED IN CONSTRUCTION WITH ARCHITECT DIMENSIONS ARE BASED ON ARCHITECTURAL DRAWINGS AS BUILT CONDITIONS MAY VARY.

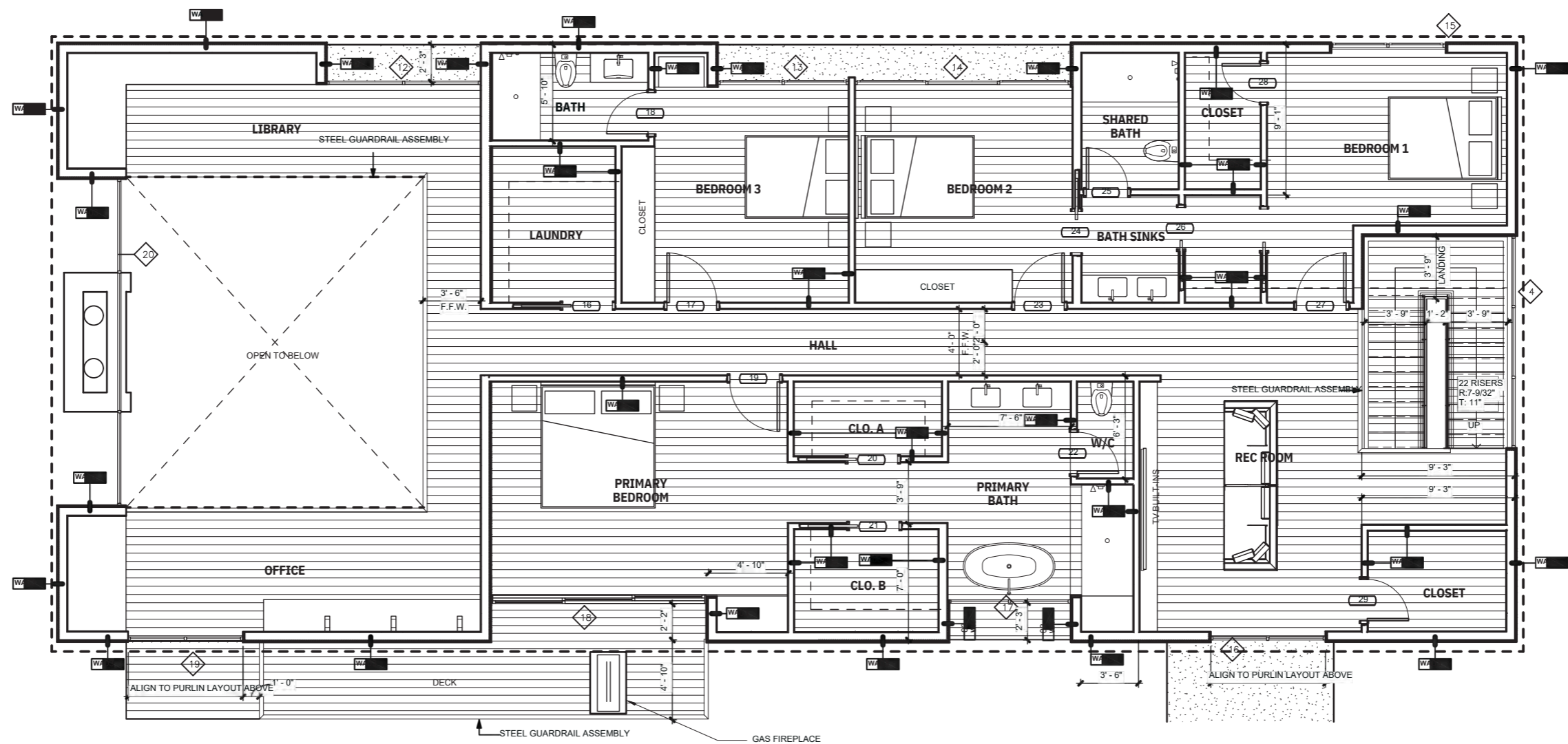

PROJECT:

DRAWING:

REVISIONS DESCRIPTION

REVISIONS	DESCRIPTION

SQ. FOOTAGE:
 INTERIOR: -
 EXTERIOR: -
 TOTAL: -

DATE:
 3-28-25
 SCALE:
 NTS
 SHEET:

FP-1.2

UPPER LEVEL FLOOR PLAN



ELYSSA CONTARDO DESIGNS
ELYSSA@ELYSSACONTARDO.COM

P// 760.579.8113

GENERAL NOTES
WRITTEN DIMENSIONS SHALL TAKE PRECEDENCE OVER SCALED DIMENSIONS AND SHALL BE VERIFIED ON JOB SITE. ANY DISCREPANCY SHALL BE BROUGHT TO THE ATTENTION OF ELYSSA CONTARDO DESIGNS FOR CLARIFICATION BEFORE PROCEEDING WITH WORK. DRAWINGS TO BE USED IN CONSTRUCTION WITH ARCHITECT DIMENSIONS ARE BASED ON ARCHITECTURAL DRAWINGS AS BUILT CONDITIONS MAY VARY.

PROJECT:
DRAWING:
2955 HERZOG DRIVE, PETALUMA, CA

REVISIONS DESCRIPTION

SQ. FOOTAGE:
INTERIOR: -
EXTERIOR: -
TOTAL: -

DATE:
3-28-25
SCALE:
NTS
SHEET:
FS

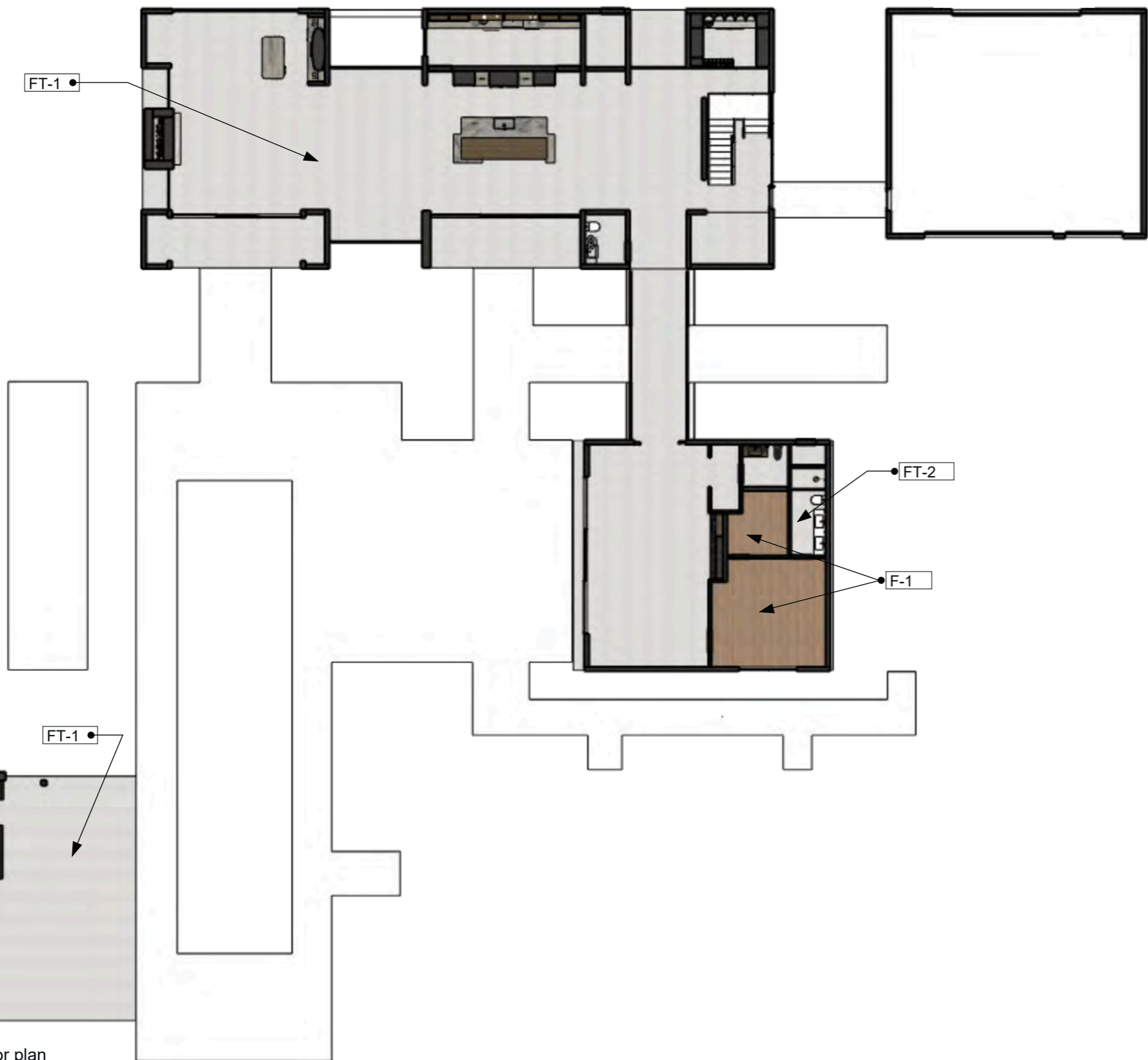

Main level floor plan



Upper level floor plan

LEGEND	
F - 1	- Engineered wood
FT - 1	- Main Flooring: Interior, Exterior 18"x36"
FT - 2	- ADU Bath Floor 18"x36"
FT - 3	- Bath 1 & 2 Floor 18"x36"
FT - 4	- Laundry Floor Cut to 18"x18"
FT - 5	- Bath 3 Floor 18"x36"
FT - 6	- Master Bath Floor 18"x36"

FLOOR SCHEME



ELYSSA CONTARDO DESIGNS
P // 760.579.8113
ELYSSA@ELYSSACONTARDO.COM

GENERAL NOTES
WRITTEN DIMENSIONS SHALL TAKE PRECEDENCE OVER SCALED DIMENSIONS AND SHALL BE VERIFIED ON JOB SITE. ANY DISCREPANCY SHALL BE BROUGHT TO THE ATTENTION OF ELYSSA CONTARDO DESIGNS FOR CLARIFICATION BEFORE PROCEEDING WITH WORK. DRAWINGS TO BE USED IN CONJUNCTION WITH ARCHITECT DRAWINGS. ALL DIMENSIONS ARE BASED ON ARCHITECTURAL DRAWINGS AS BUILT CONDITIONS MAY VARY.

DRAWING:
2955 HERZOG DRIVE, PETALUMA, CA

REVISIONS	DESCRIPTION

SQ. FOOTAGE:
INTERIOR: -
EXTERIOR: -
TOTAL: -

DATE:
3-28-25
SCALE:
NTS
SHEET:

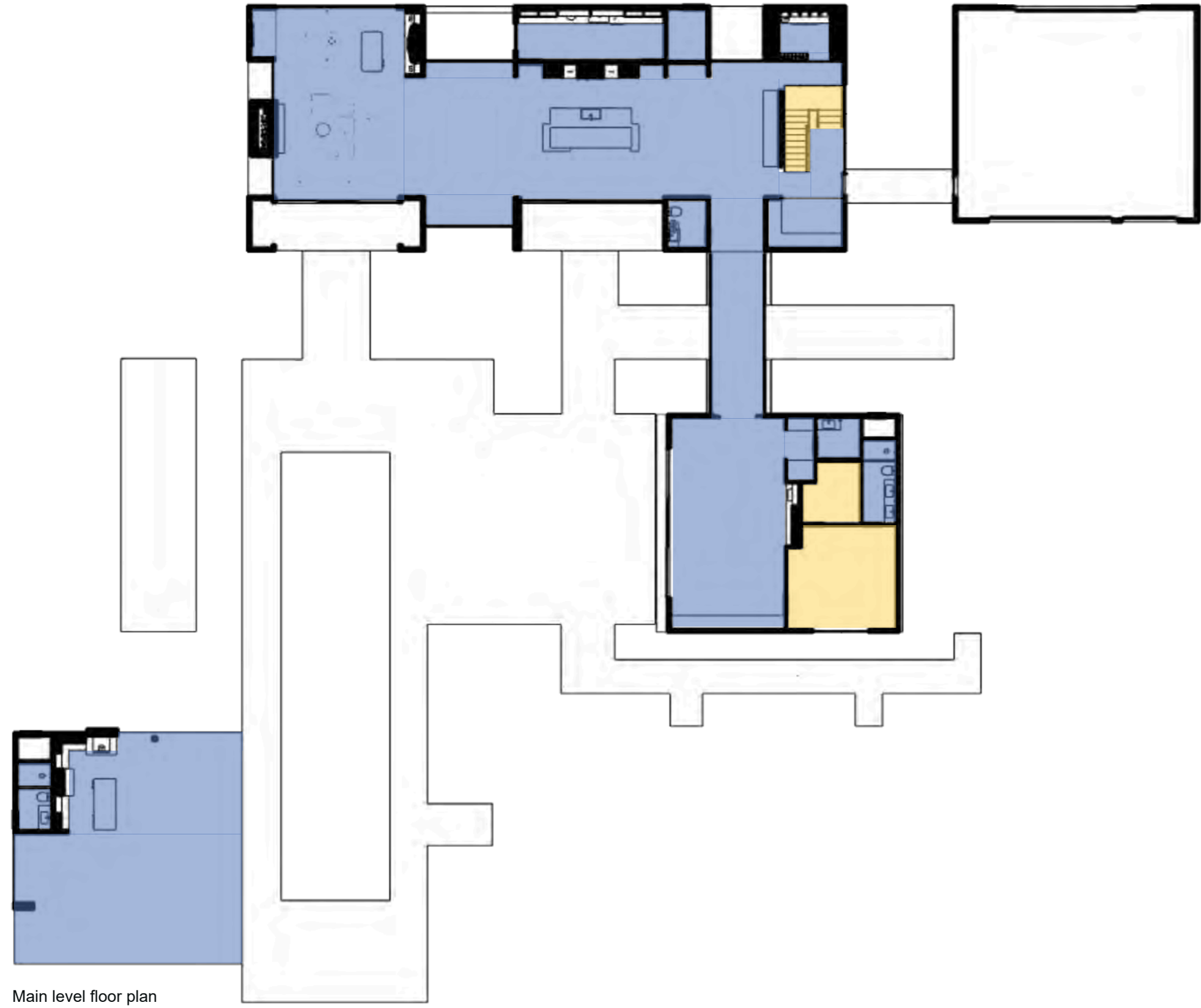

Main level floor plan



Upper level floor plan

LEGEND

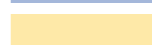
	Tile
	Hardwood

PROJECT:

FLOOR PLAN - FLOOR FINISHES

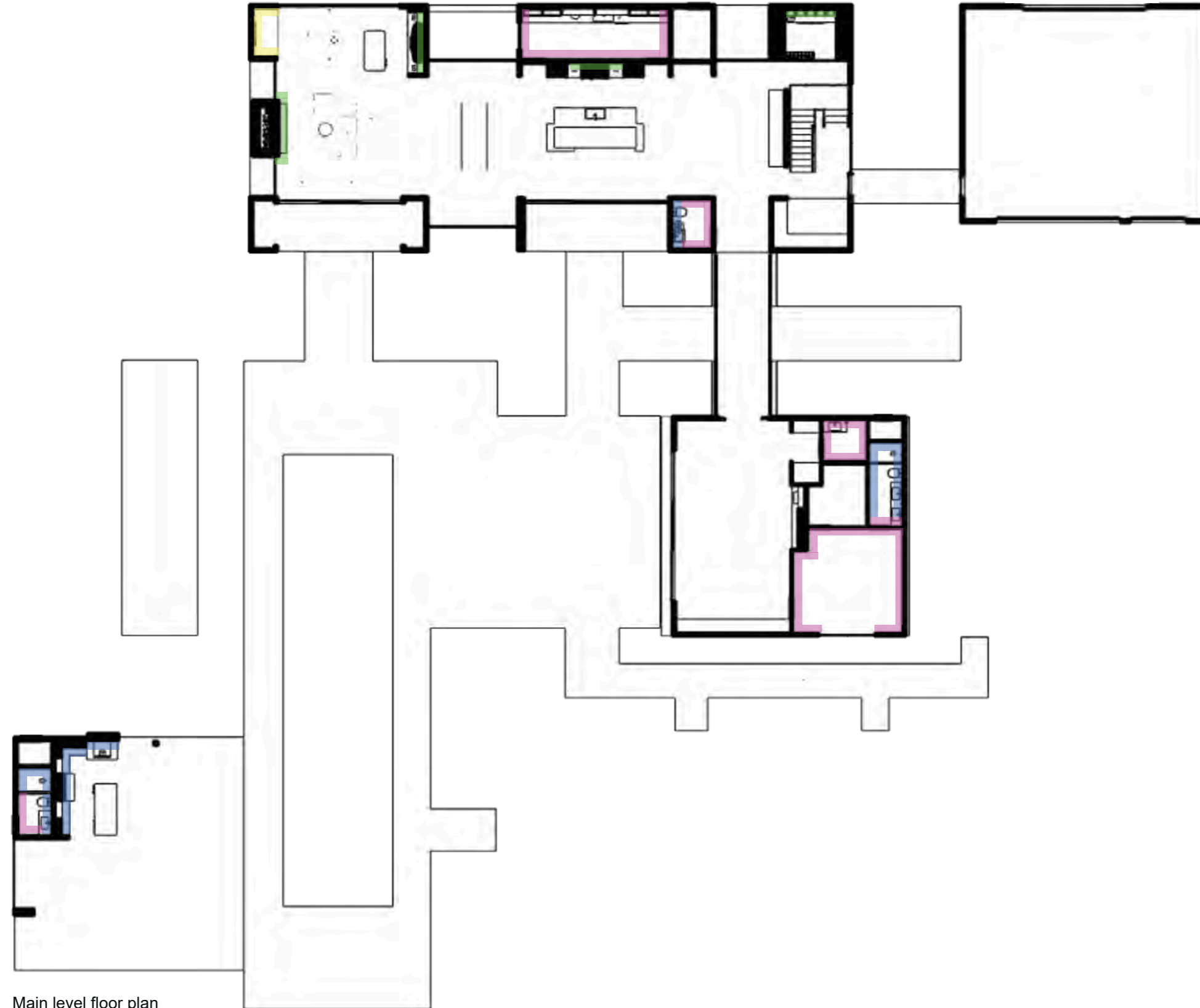

Main level floor plan



Upper level floor plan

LEGEND

	TILE
	STONE
	PLASTER
	WOOD PANELING
	METAL PANELING

FLOOR PLAN - WALL FINISHES



ELYSSA CONTARDO DESIGNS
P// 760.579.8113
ELYSSA@ELYSSACONTARDO.COM

GENERAL NOTES
WRITTEN DIMENSIONS SHALL TAKE PRECEDENCE OVER SCALED DIMENSIONS AND SHALL BE VERIFIED ON JOB SITE. ANY DISCREPANCY SHALL BE BROUGHT TO THE ATTENTION OF ELYSSA CONTARDO DESIGNS FOR CLARIFICATION BEFORE PROCEEDING WITH WORK. DRAWINGS TO BE USED IN CONSTRUCTION WITH ARCHITECT DRAWINGS. ALL DIMENSIONS ARE BASED ON ARCHITECTURAL DRAWINGS AS BUILT CONDITIONS MAY VARY.

DRAWING: 2955 HERZOG DRIVE, PETALUMA, CA

REVISIONS	DESCRIPTION

SQ. FOOTAGE:
INTERIOR: -
EXTERIOR: -
TOTAL: -

DATE: 3-28-25
SCALE: NTS
SHEET:

Kitchen

MATERIALS

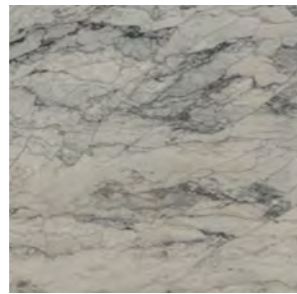

CT-1 & WS-1
HONED

• THE KITCHEN ISLAND
SINK IS INTEGRATED
FROM THE SAME SLAB
AS THE COUNTERTOP

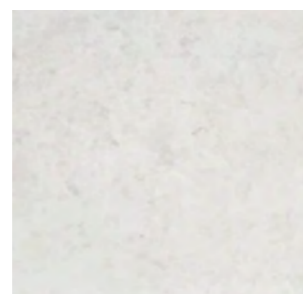

FT-1
ARGARWOOD HONED
SIZE: 18" X 36"



PT-1
CEILINGS & WALLS
PORTOLA PAINTS
LIMEWASH OR PLASTER
COLOR: PARLIAMENT

STAIN - 1
DOORS
MATCH TO DESIGNERS SAMPLE



P-?
FAUCET
DARK PLATINUM
MATTE FINISH



CAB-1
WOOD TYPE: ?



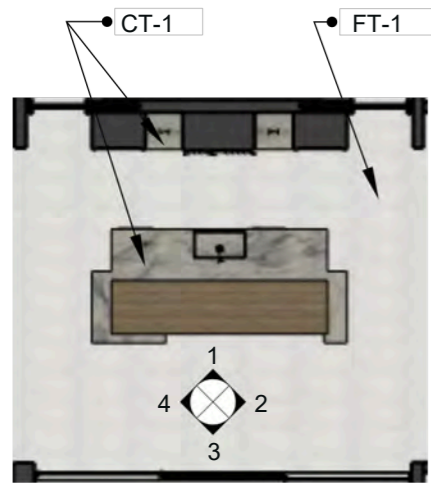

Kitchen Top View
SCALE: 3/32" = 1'-0" (1:128)

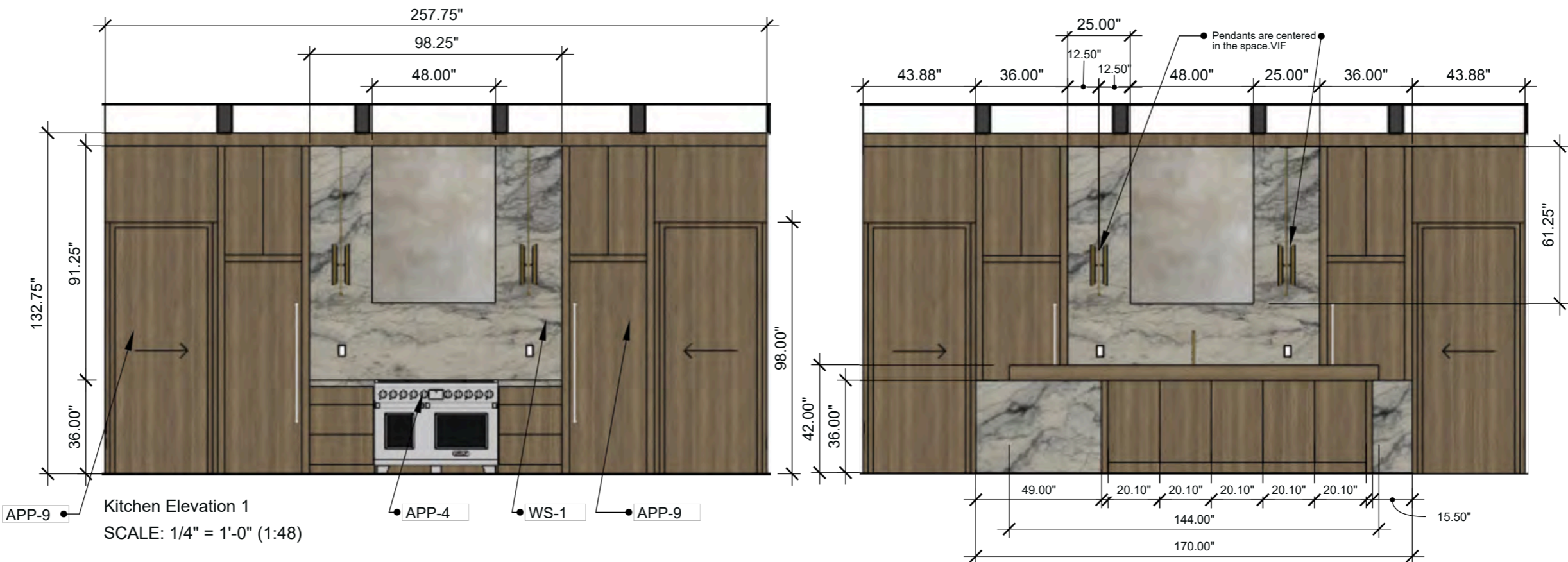

Kitchen Elevation 1
SCALE: 1/4" = 1'-0" (1:48)

Kitchen Elevation 1.1
SCALE: 1/4" = 1'-0" (1:48)

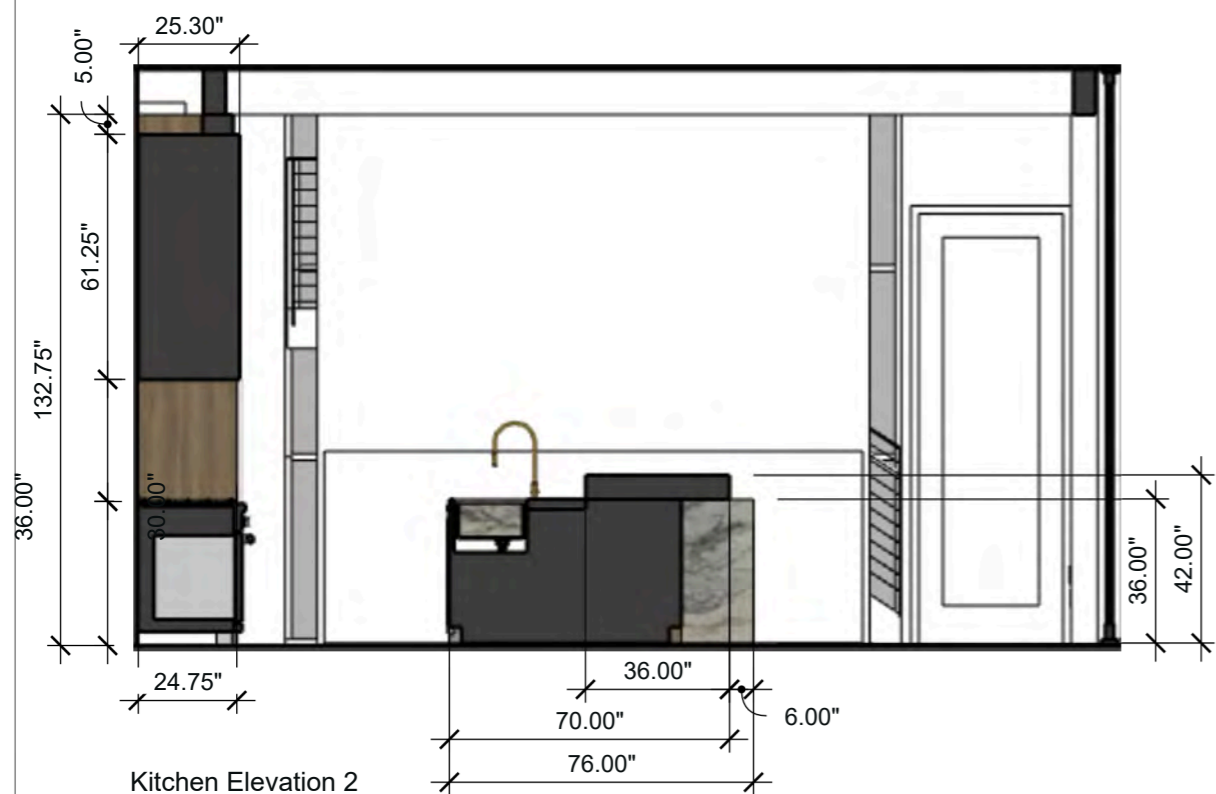

Kitchen Elevation 2
SCALE: 1/4" = 1'-0" (1:48)

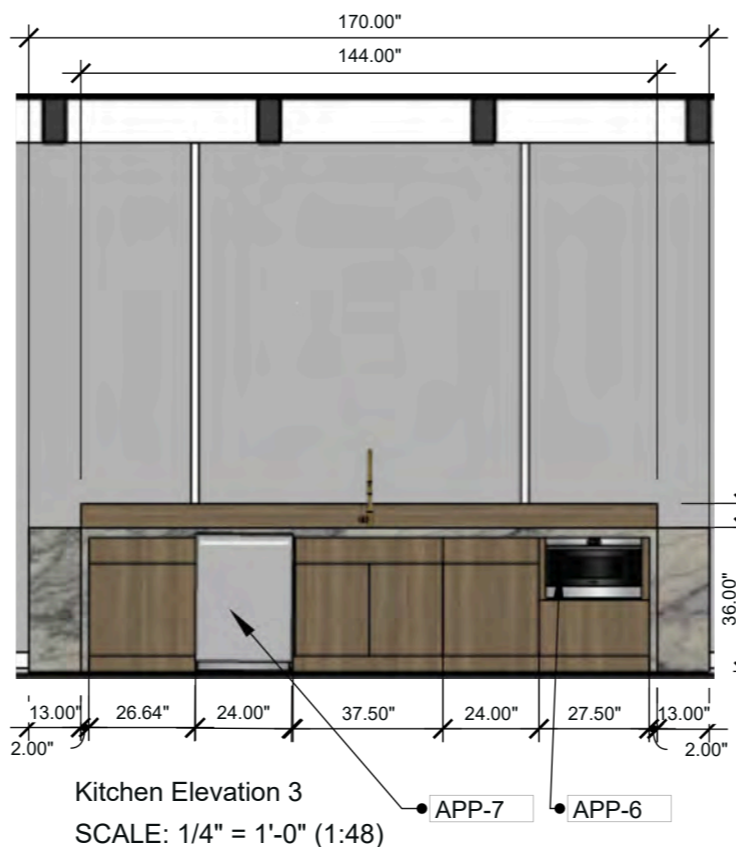

Kitchen Elevation 3
SCALE: 1/4" = 1'-0" (1:48)

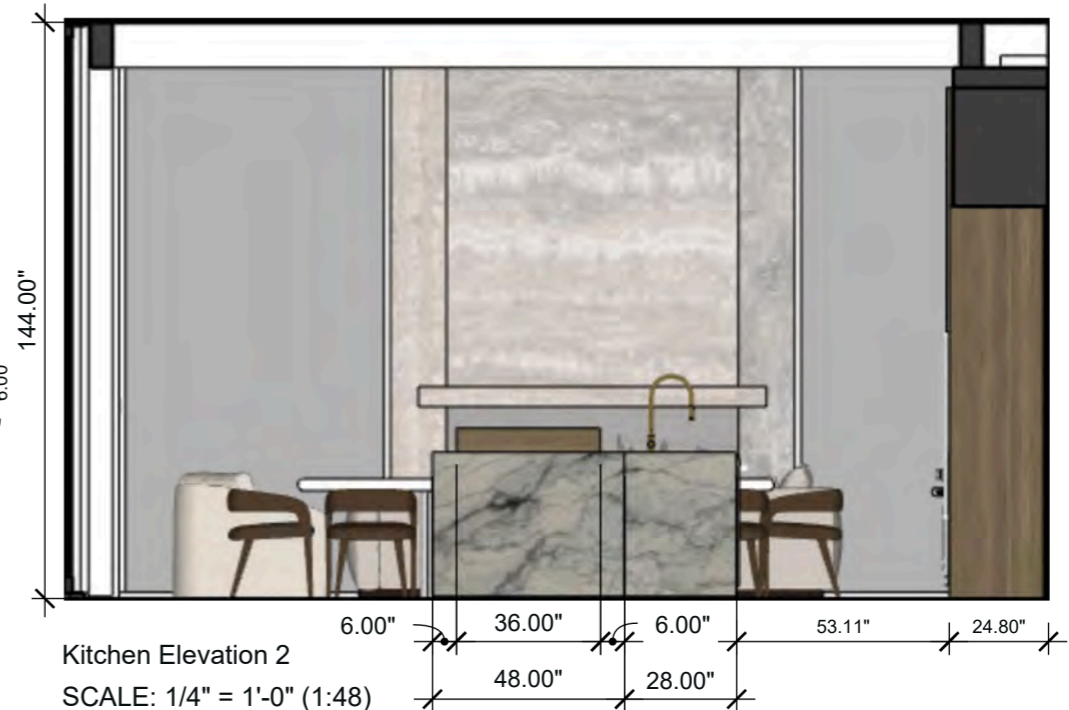

Kitchen Elevation 2
SCALE: 1/4" = 1'-0" (1:48)



ELYSSA CONTARDO DESIGNS
P // 760.579.8113
ELYSSA@ELYSSACONTARDO.COM

GENERAL NOTES
WRITTEN DIMENSIONS SHALL TAKE PRECEDENCE OVER SCALED DIMENSIONS AND SHALL BE VERIFIED ON JOB SITE. ANY DISCREPANCY SHALL BE BROUGHT TO THE ATTENTION OF ELYSSA CONTARDO DESIGNS FOR CLARIFICATION BEFORE PROCEEDING WITH WORK. DRAWINGS TO BE USED IN CONJUNCTION WITH ARCHITECT DRAWINGS. ALL DIMENSIONS ARE BASED ON ARCHITECTURAL DRAWINGS AS BUILT CONDITIONS MAY VARY.

DRAWING:
PROJECT:
2955 HERZOG COURT, PETALUMA, CA

REVISIONS	DESCRIPTION

SQ. FOOTAGE:
INTERIOR: -
EXTERIOR: -
TOTAL: -

DATE:
SCALE:
NTS
SHEET:

I-1

KITCHEN ELEVATIONS



ELYSSA CONTARDO DESIGNS
P// 760.579.8113
ELYSSA@ELYSSACONTARDO.COM

GENERAL NOTES:
WRITTEN DIMENSIONS SHALL TAKE PRECEDENCE OVER SCALED DIMENSIONS AND SHALL BE VERIFIED ON JOB SITE. ANY DISCREPANCY SHALL BE BROUGHT TO THE ATTENTION OF ELYSSA CONTARDO DESIGNS FOR CLARIFICATION BEFORE PROCEEDING WITH WORK. DRAWINGS TO BE USED IN CONJUNCTION WITH ARCHITECT DRAWINGS. ALL DIMENSIONS ARE BASED ON ARCHITECTURAL DRAWINGS. AS BUILT CONDITIONS MAY VARY.

DRAWING:
PROJECT:
2955 HERZOG COURT, PETALUMA, CA

REVISIONS	DESCRIPTION

SQ. FOOTAGE:
INTERIOR: -
EXTERIOR: -
TOTAL: -

DATE:
1-7-25
SCALE:
NTS
SHEET:
I-1.1

KITCHEN 3D RENDERING

Butler's Pantry

MATERIALS

PT-1
CEILINGS & WALLS
 PORTOLA PAINTS
 LIMEWASH OR PLASTER
 COLOR: PARLIAMENT

STAIN - 1
DOORS
 MATCH TO DESIGNERS SAMPLE



GLASS

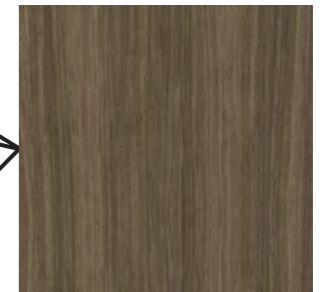

CAB-1
 WOOD TYPE: ?

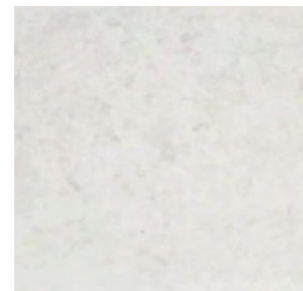

FT-1
 ARGARWOOD HONED
 SIZE: 18"X36"



P-?
FAUCET
 PEWTER FINISH



P-?
SINK
 WHITE

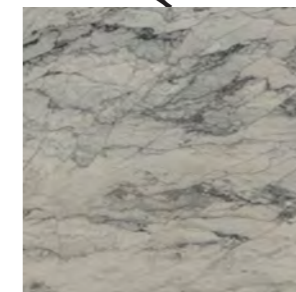

CT-1 & WS-1
 HONED





BUTLER'S PANTRY 3D RENDERING



ELYSSA CONTARDO DESIGNS
P // 760.579.8113
ELYSSA@ELYSSACONTARDO.COM

GENERAL NOTES
WRITTEN DIMENSIONS SHALL TAKE PRECEDENCE OVER SCALED DIMENSIONS AND SHALL BE VERIFIED ON JOB SITE. ANY DISCREPANCY SHALL BE BROUGHT TO THE ATTENTION OF ELYSSA CONTARDO DESIGNS FOR CLARIFICATION BEFORE PROCEEDING WITH WORK. DRAWINGS TO BE USED IN CONSTRUCTION WITH ARCHITECT DIMENSIONS ARE BASED ON ARCHITECTURAL DRAWINGS. AS BUILT CONDITIONS MAY VARY.

DRAWING:

PROJECT:
2955 HERZOG COURT, PETALUMA, CA

REVISIONS	DESCRIPTION

SQ. FOOTAGE:
INTERIOR: -
EXTERIOR: -
TOTAL: -

DATE:
1-7-25
SCALE:
NTS
SHEET:

1-2.1

Great Room Bar

MATERIALS

PT-1
CEILINGS & WALLS
 PORTOLA PAINTS
 LIMEWASH OR PLASTER
 COLOR: PARLIAMENT

STAIN - 1
DOORS
 MATCH TO DESIGNERS SAMPLE



P-?
FAUCET
 PEWTER

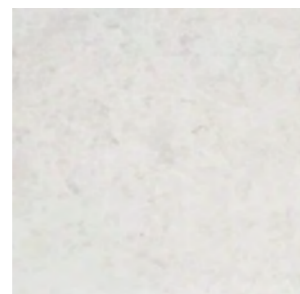

FT-1
ARGARWOOD HONED
 SIZE: 18"X36"



METAL



CAB-1
WOOD TYPE: ?



P-?
SINK
 COAL BLACK



CT-1 & WS-1
HONED

WOOD



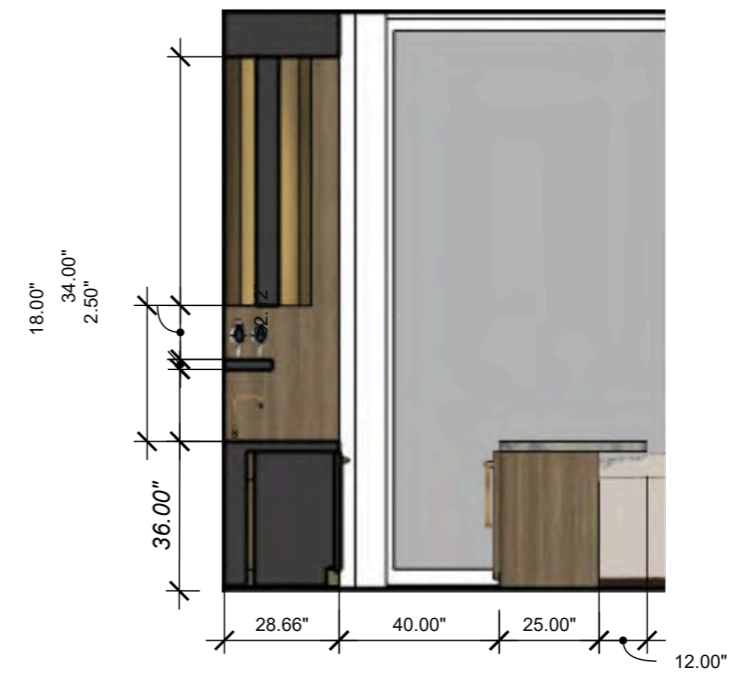
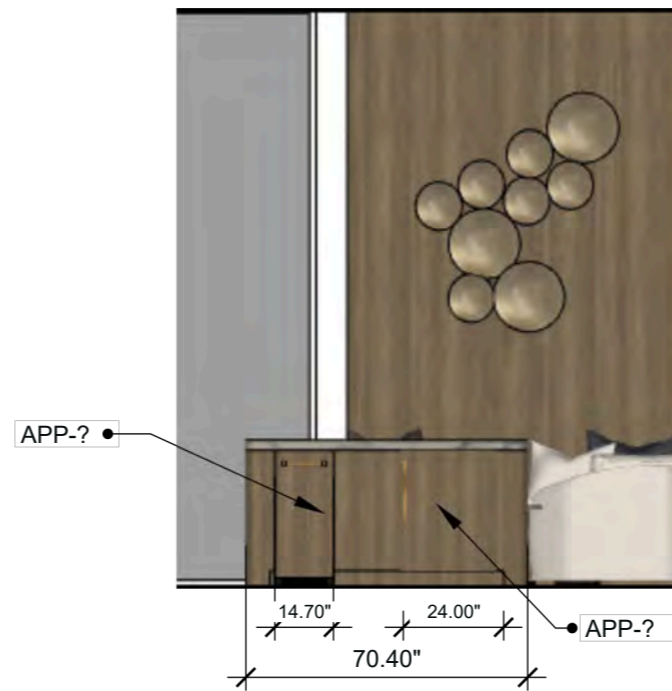
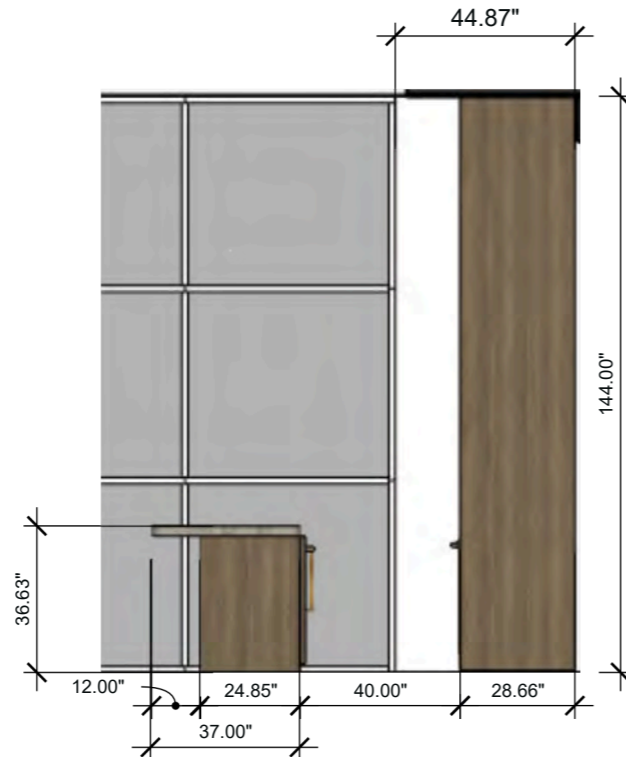
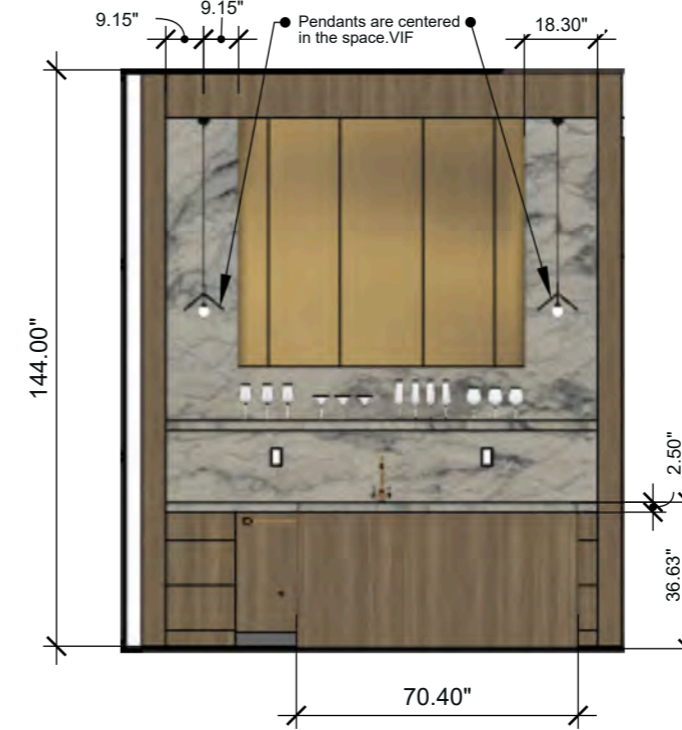
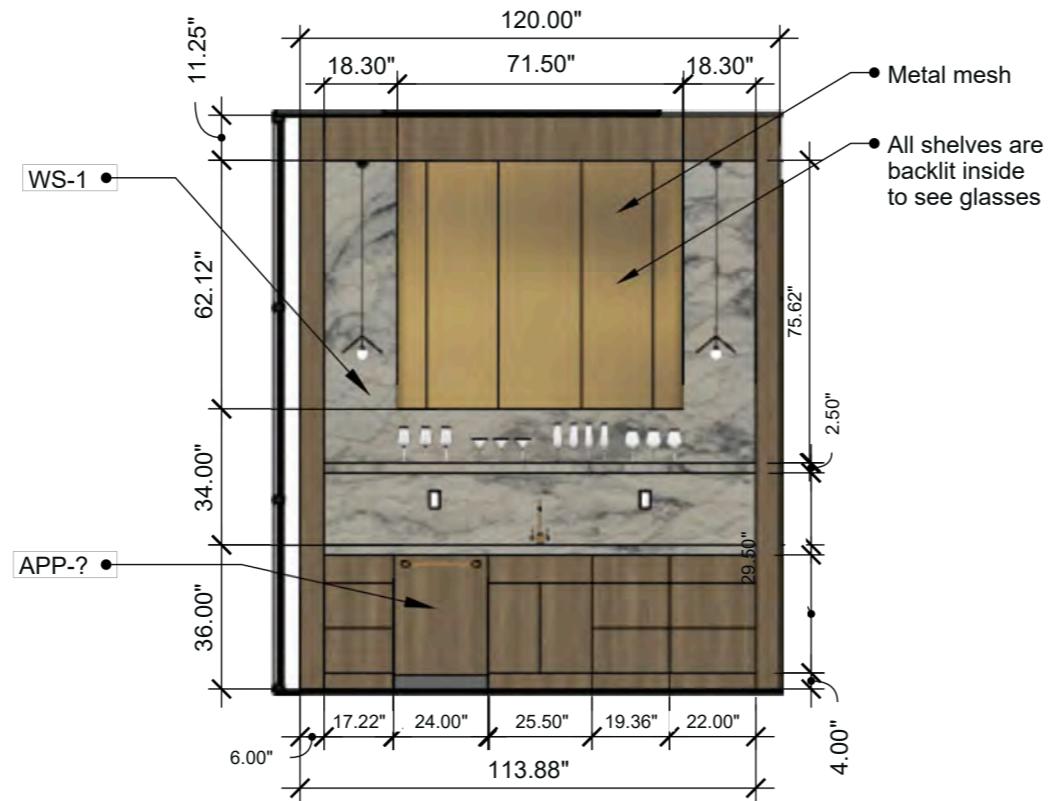
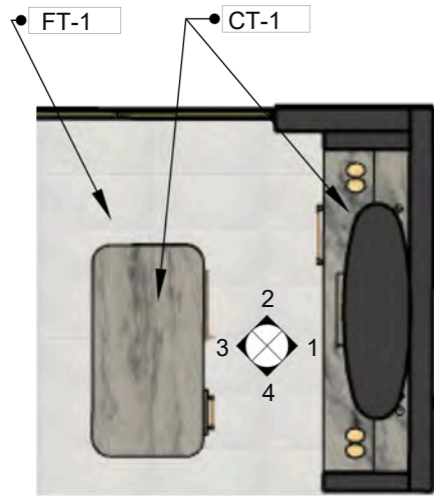

GREAT ROOM BAR ELEVATIONS



ELYSSA CONTARDO DESIGNS
P // 760.579.8113
ELYSSA@ELYSSACONTARDO.COM

GENERAL NOTES
WRITTEN DIMENSIONS SHALL TAKE PRECEDENCE OVER SCALED DIMENSIONS AND SHALL BE VERIFIED ON JOB SITE. ANY DISCREPANCY SHALL BE BROUGHT TO THE ATTENTION OF ELYSSA CONTARDO DESIGNS FOR CLARIFICATION BEFORE PROCEEDING WITH WORK. DRAWINGS TO BE USED IN CONJUNCTION WITH ARCHITECT DRAWINGS. ALL DIMENSIONS ARE BASED ON ARCHITECTURAL DRAWINGS AS BUILT CONDITIONS MAY VARY.

DRAWING:

PROJECT:
2955 HERZOG COURT, PETALUMA, CA

REVISIONS	DESCRIPTION

SQ. FOOTAGE:
INTERIOR: -
EXTERIOR: -
TOTAL: -

DATE: 1-7-25
SCALE: NTS
SHEET:

1-3

Powder

MATERIALS

PT-1
CEILINGS & WALLS
PORTOLA PAINTS
LIMEWASH OR PLASTER
COLOR: PARLIAMENT

STAIN - 1
DOORS
MATCH TO DESIGNERS SAMPLE



P-?
FANTINI ICONA 12"
GUN METAL
QTY: 1



P-?
FANTINI
GUN METAL
QTY: 1

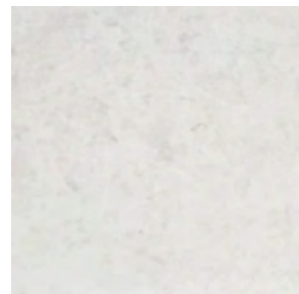

FT-1
ARGARWOOD HONED
SIZE: 18"X36"

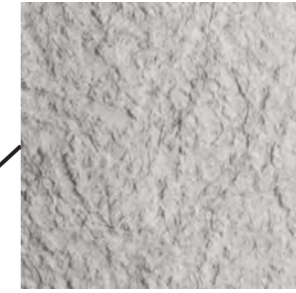
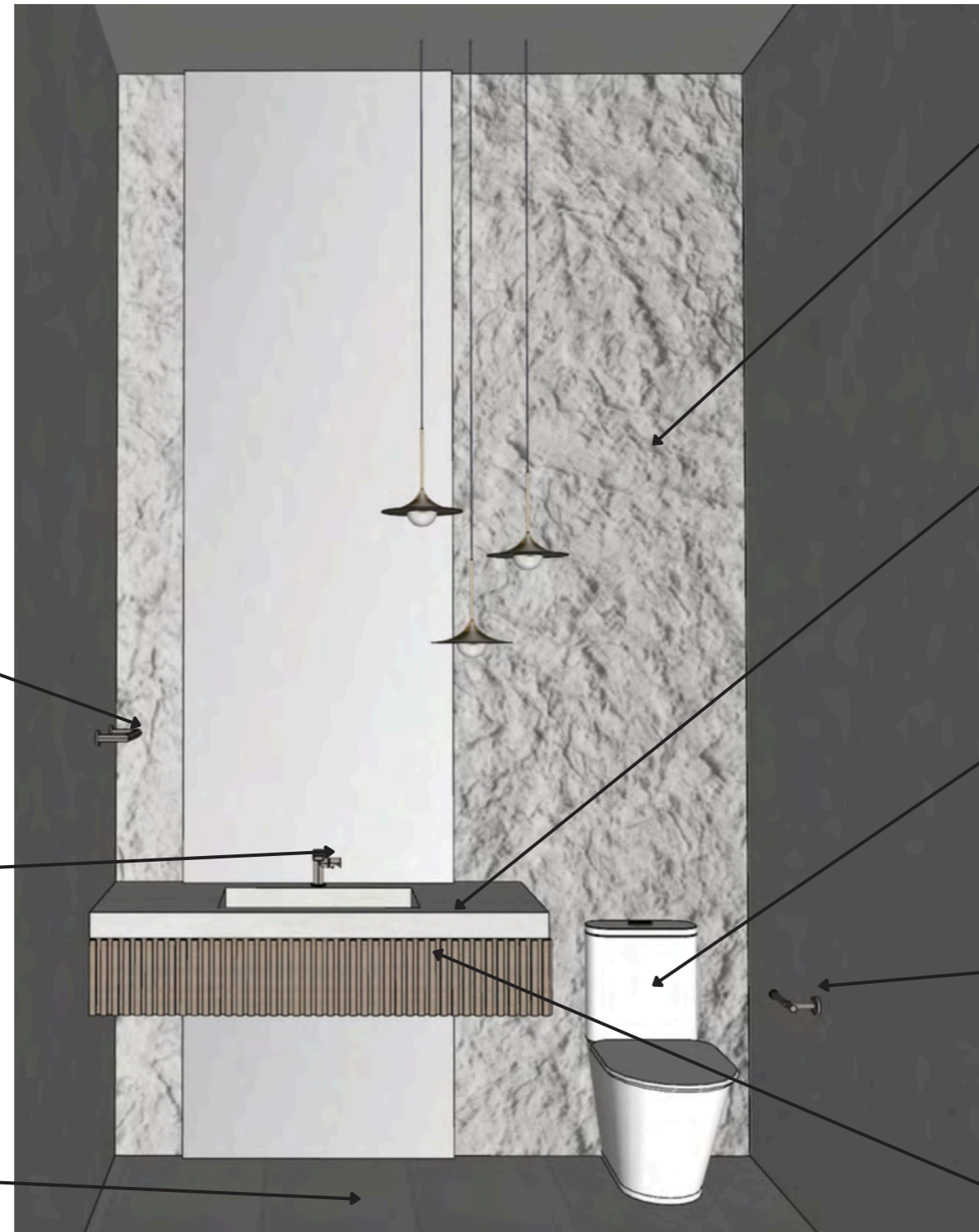

WS-3



CT-2



P-?
TOTO
COTTON WHITE
QTY: 1



P-?
FANTINI ICONA
GUN METAL
QTY: 1



CAB?



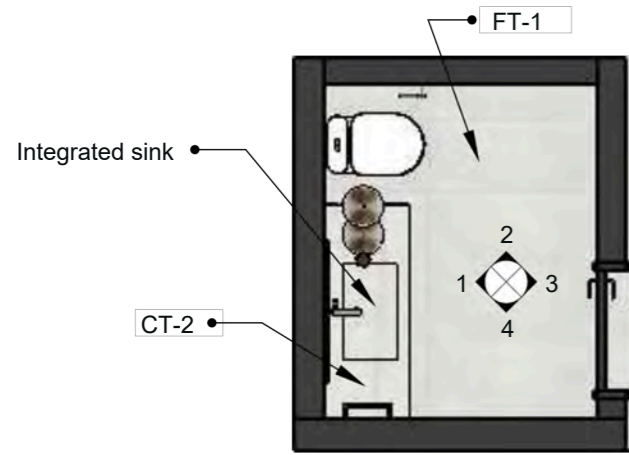

Powder Top View
SCALE: 1/4" = 1'-0" (1:48)

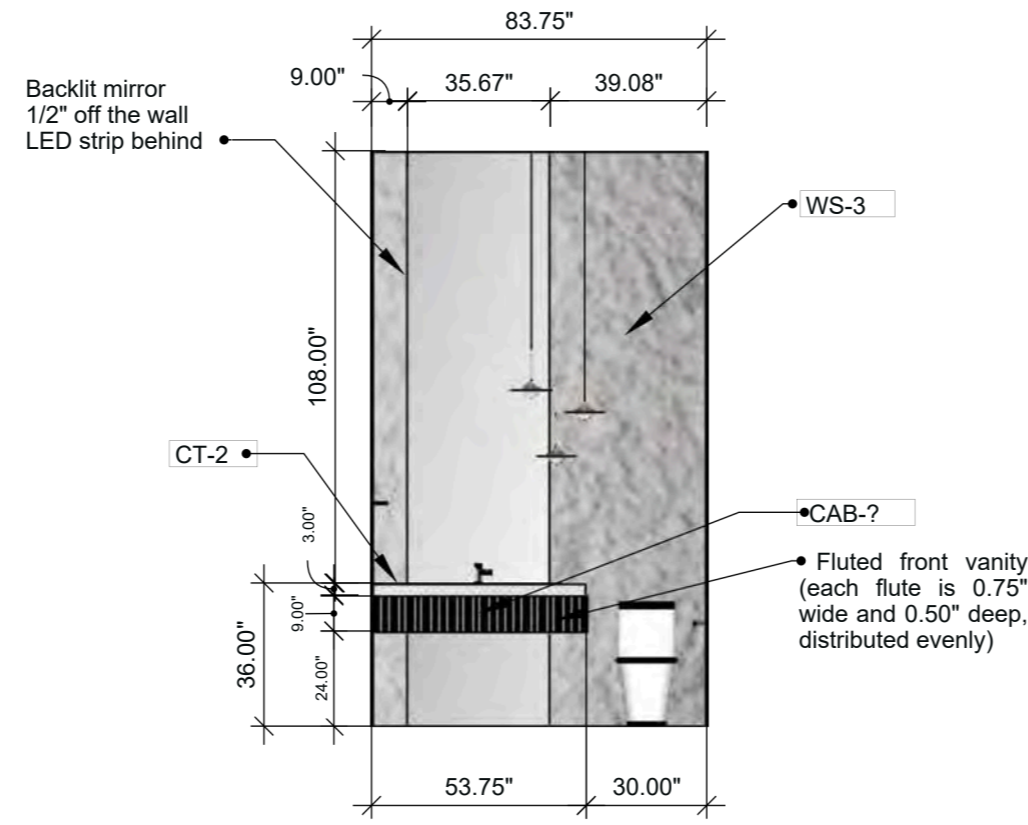

Powder Elevation 1
SCALE: 1/4" = 1'-0" (1:48)

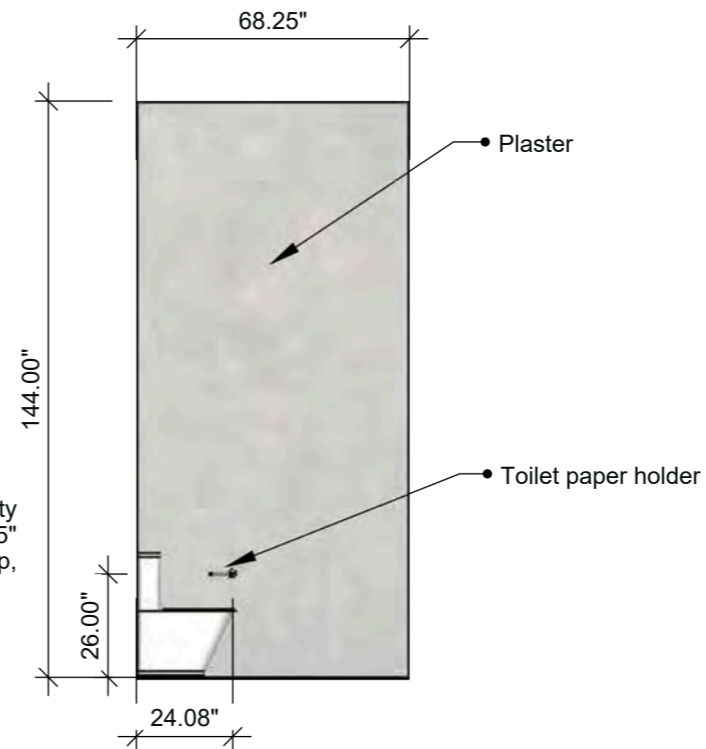

Powder Elevation 2
SCALE: 1/4" = 1'-0" (1:48)

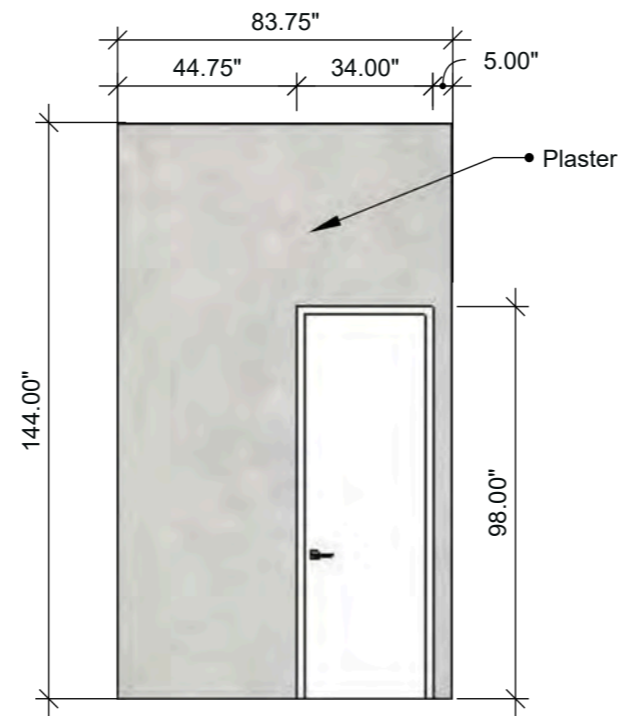

Powder Elevation 3
SCALE: 1/4" = 1'-0" (1:48)

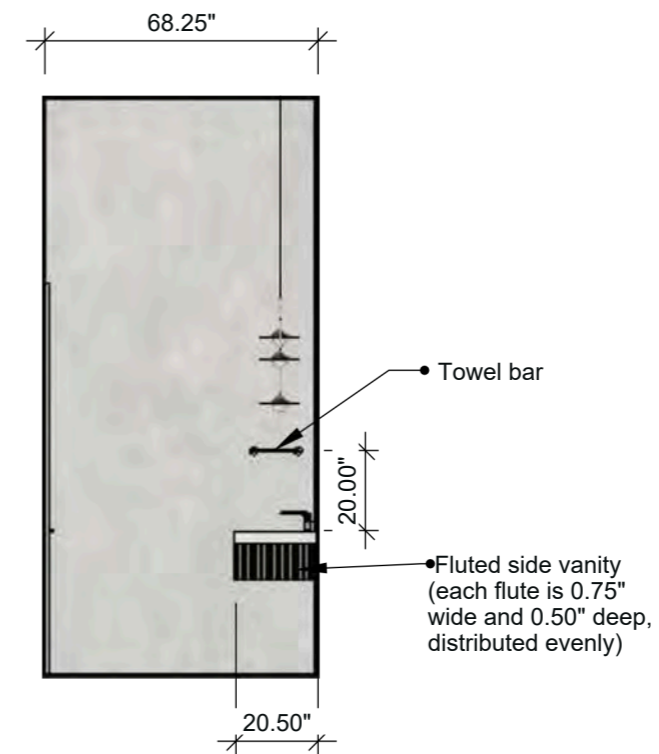

Powder Elevation 4
SCALE: 1/4" = 1'-0" (1:48)

POWDER ELEVATIONS



ELYSSA CONTARDO DESIGNS
P // 760.579.8113
ELYSSA@ELYSACONTARDO.COM

GENERAL NOTES
WRITTEN DIMENSIONS SHALL TAKE PRECEDENCE OVER SCALED DIMENSIONS AND SHALL BE VERIFIED ON JOB SITE. ANY DISCREPANCY SHALL BE BROUGHT TO THE ATTENTION OF ELYSSA CONTARDO DESIGNS FOR CLARIFICATION BEFORE PROCEEDING WITH WORK. DRAWINGS TO BE USED IN CONSTRUCTION SHALL BE ARCHITECT DRAWINGS. ALL DIMENSIONS ARE BASED ON ARCHITECTURAL DRAWINGS AS BUILT CONDITIONS MAY VARY.

DRAWING:
PROJECT: 2955 HERZOG COURT, PETALUMA, CA

REVISIONS	DESCRIPTION

SQ. FOOTAGE:
INTERIOR: -
EXTERIOR: -
TOTAL: -
DATE: 1-7-25
SCALE: NTS
SHEET: |-4

Laundry

MATERIALS

PT-1
CEILINGS & WALLS
 PORTOLA PAINTS
 LIMEWASH OR PLASTER
 COLOR: PARLIAMENT

STAIN - 1
DOORS
 MATCH TO DESIGNERS SAMPLE



P-?
FAUCET
 SATIN NICKEL



P-?
SINK
 SATIN POLISH



CAB-1
 WOOD TYPE: ?



CT-6
 SILVER TRAVERTINE

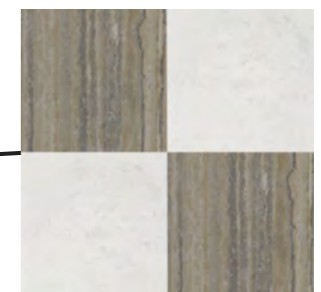

FT-4
 SILVER
 TRAVERTIN/AGARWOOD
 LIMESTONE
 SIZE: CUT TO 18"X18"



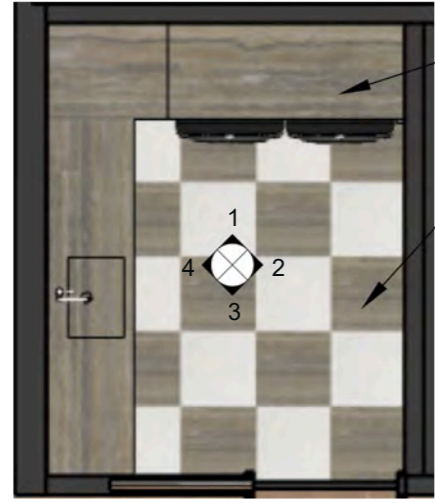

Laundry Top View
SCALE: 1/4" = 1'-0" (1:48)

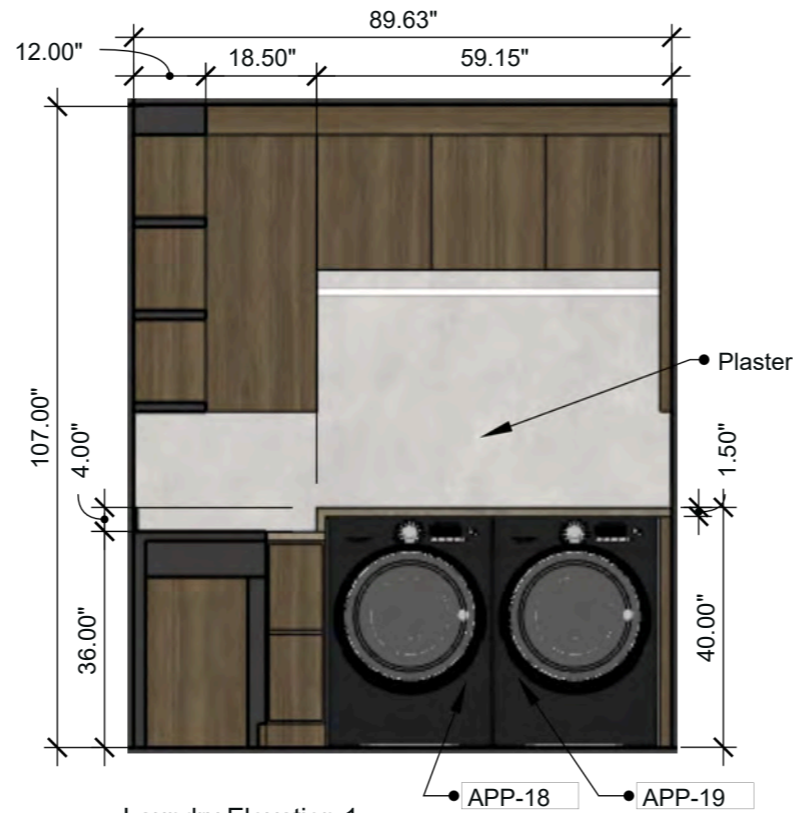

Laundry Elevation 1
SCALE: 3/8" = 1'-0" (1:32)

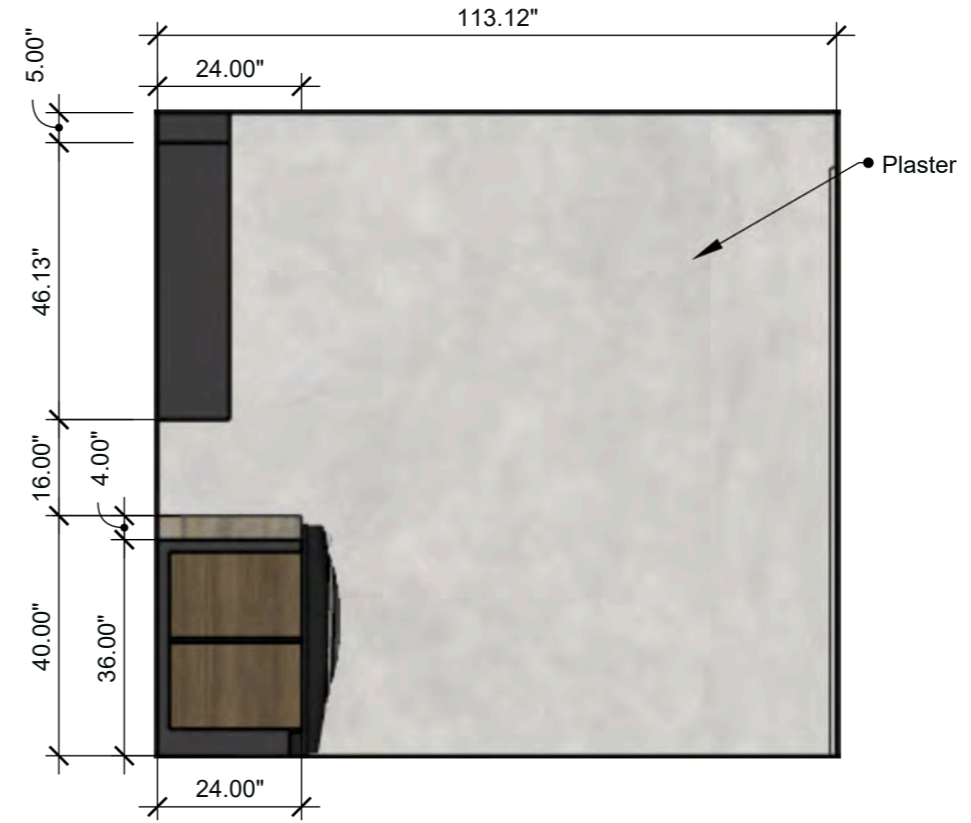

Laundry Elevation 2
SCALE: 3/8" = 1'-0" (1:32)

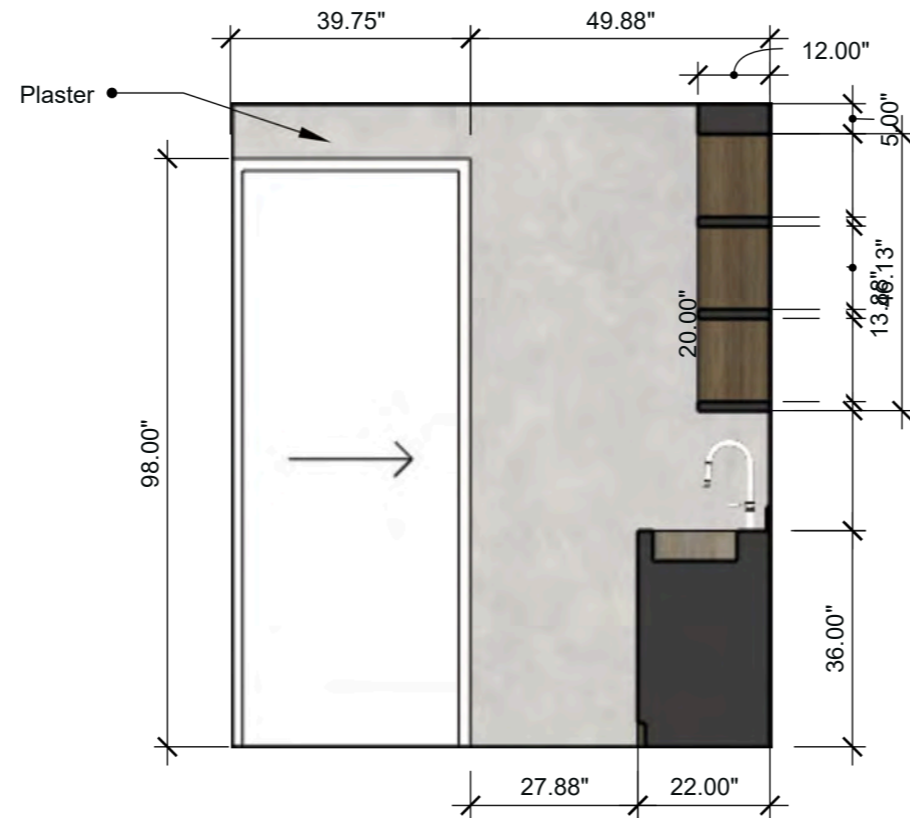

Laundry Elevation 3
SCALE: 3/8" = 1'-0" (1:32)

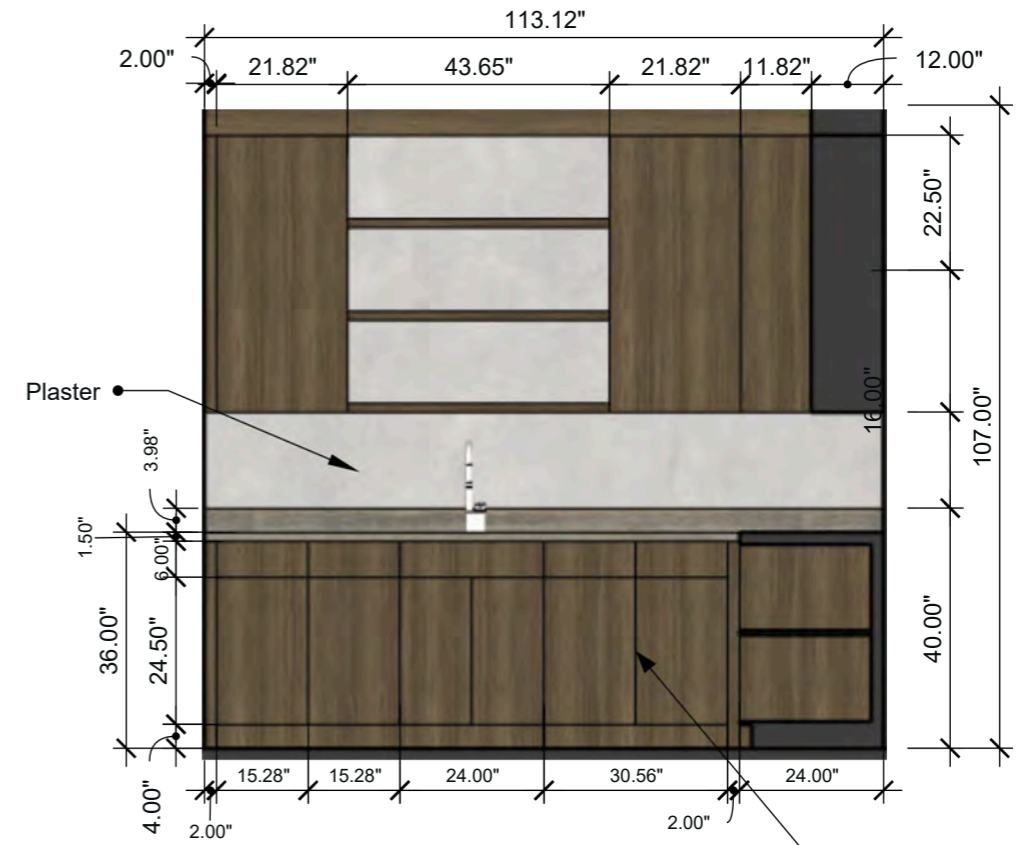

Laundry Elevation 4
SCALE: 3/8" = 1'-0" (1:32)

LAUNDRY ELEVATIONS



ELYSSA CONTARDO DESIGNS
P// 760.579.8113
ELYSSA@ELYSSACONTARDO.COM

GENERAL NOTES
WRITTEN DIMENSIONS SHALL TAKE PRECEDENCE OVER SCALED DIMENSIONS AND SHALL BE VERIFIED ON JOB SITE. ANY DISCREPANCY SHALL BE BROUGHT TO THE ATTENTION OF ELYSSA CONTARDO DESIGNS FOR CLARIFICATION BEFORE PROCEEDING WITH WORK. DRAWINGS TO BE USED IN CONNECTION WITH ARCHITECT DRAWINGS. ALL DIMENSIONS ARE BASED ON ARCHITECTURAL DRAWINGS AS BUILT CONDITIONS MAY VARY.

DRAWING:
PROJECT:
2955 HERZOG COURT, PETALUMA, CA

REVISIONS	DESCRIPTION

SQ. FOOTAGE:
INTERIOR: -
EXTERIOR: -
TOTAL: -

DATE:
1-7-25
SCALE:
NTS
SHEET:
1-5



LAUNDRY 3D RENDERING



ELYSSA CONTARDO DESIGNS
 P// 760.579.8113
 ELYSSA@ELYSSACONTARDO.COM

GENERAL NOTES:
 WRITTEN DIMENSIONS SHALL TAKE PRECEDENCE OVER SCALED DIMENSIONS AND SHALL BE VERIFIED ON JOB SITE. ANY DISCREPANCY SHALL BE BROUGHT TO THE ATTENTION OF ELYSSA CONTARDO DESIGNS FOR CLARIFICATION BEFORE PROCEEDING WITH WORK. DRAWINGS TO BE USED IN CONJUNCTION WITH ARCHITECT DRAWINGS. ALL DIMENSIONS ARE BASED ON ARCHITECTURAL DRAWINGS AS BUILT CONDITIONS MAY VARY.

DRAWING:
 PROJECT:
 2955 HERZOG COURT, PETALUMA, CA

REVISIONS	DESCRIPTION

SQ. FOOTAGE:
 INTERIOR: -
 EXTERIOR: -
 TOTAL: -
 DATE: 1-7-25
 SCALE: NTS
 SHEET: I-5.1

Bath 3

MATERIALS

**PT-1
CEILINGS & WALLS**
PORTOLA PAINTS
LIMEWASH OR PLASTER
COLOR: PARLIAMENT

**STAIN - 1
DOORS**
MATCH TO DESIGNERS SAMPLE



**WT-8
CORINTHIAN BEIGE**
SIZE: 12"X24"



**PT-?
TOTO**
COTTON WHITE



**P-?
LINEAR DRAIN**
SATIN STAINLESS STEEL



**P-?
KOHLER**
VIBRANT
BRUSHED
NICKEL



**P-?
KOHLER**
VIBRANT
BRUSHED
NICKEL



**P-?
KOHLER**
VIBRANT
BRUSHED
NICKEL



**P-?
KOHLER**
VIBRANT
BRUSHED
NICKEL



**P-?
FAUCET**
VIBRANT BRUSHED NICKEL



**P-?
SINK**
WHITE

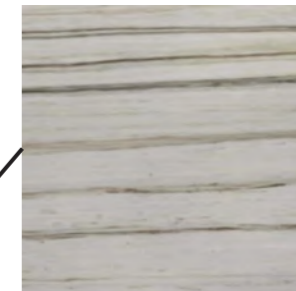

**CT-7
POLISHED**



**CAB-1
WOOD TYPE: ?**

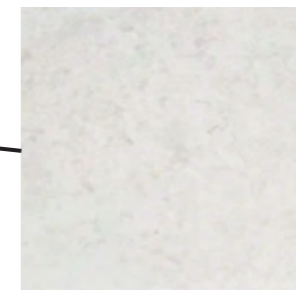

**FT-5
AGARWOOD LIMESTONE**
SIZE: 18"X36"



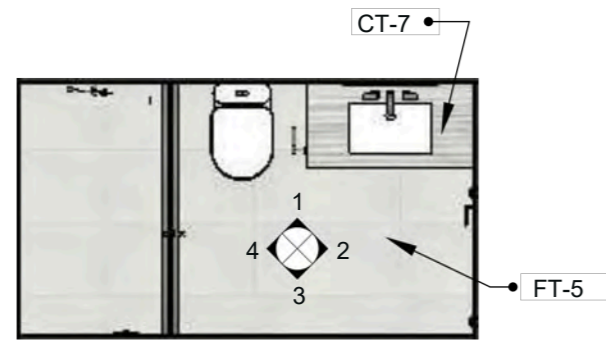

Bath 3 Top View
SCALE: 1/4" = 1'-0" (1:48)

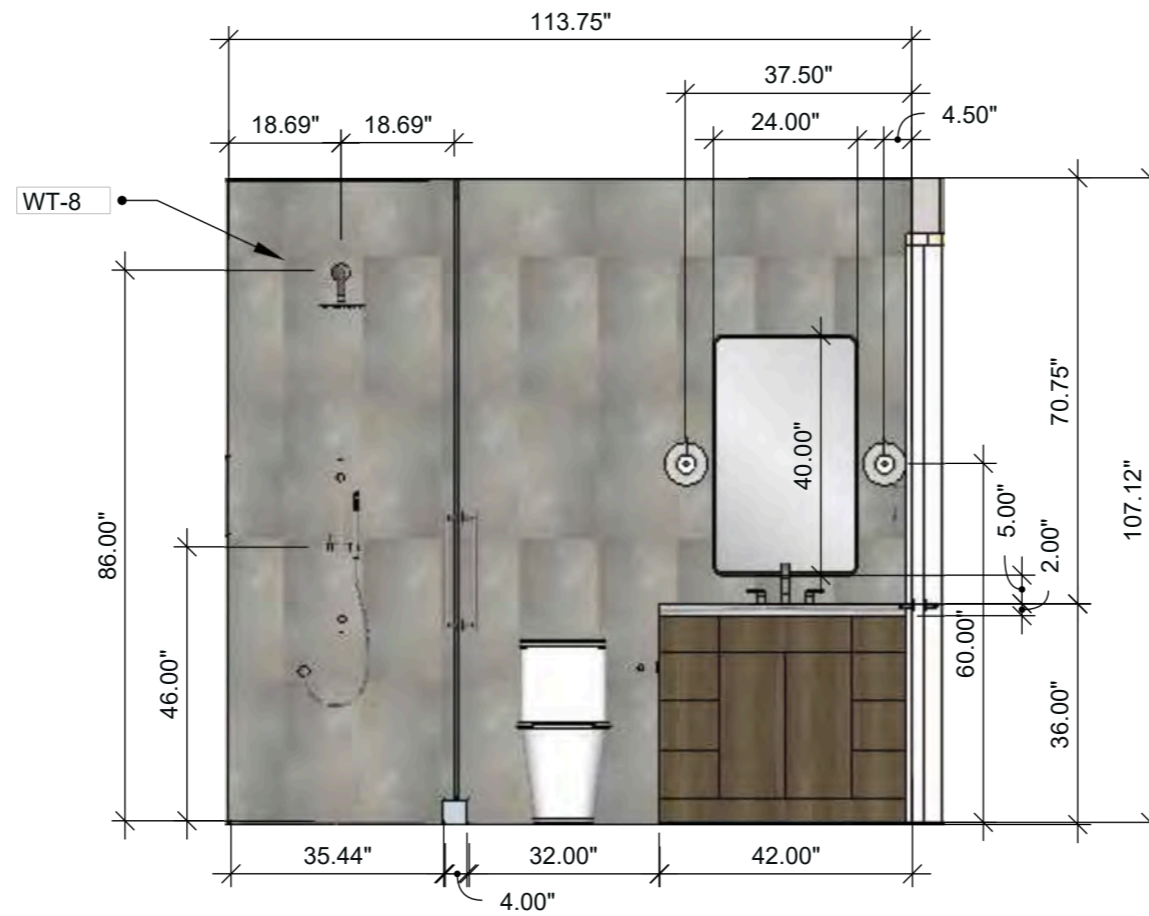

Bath 3 Elevation 1
SCALE: 3/8" = 1'-0" (1:32)

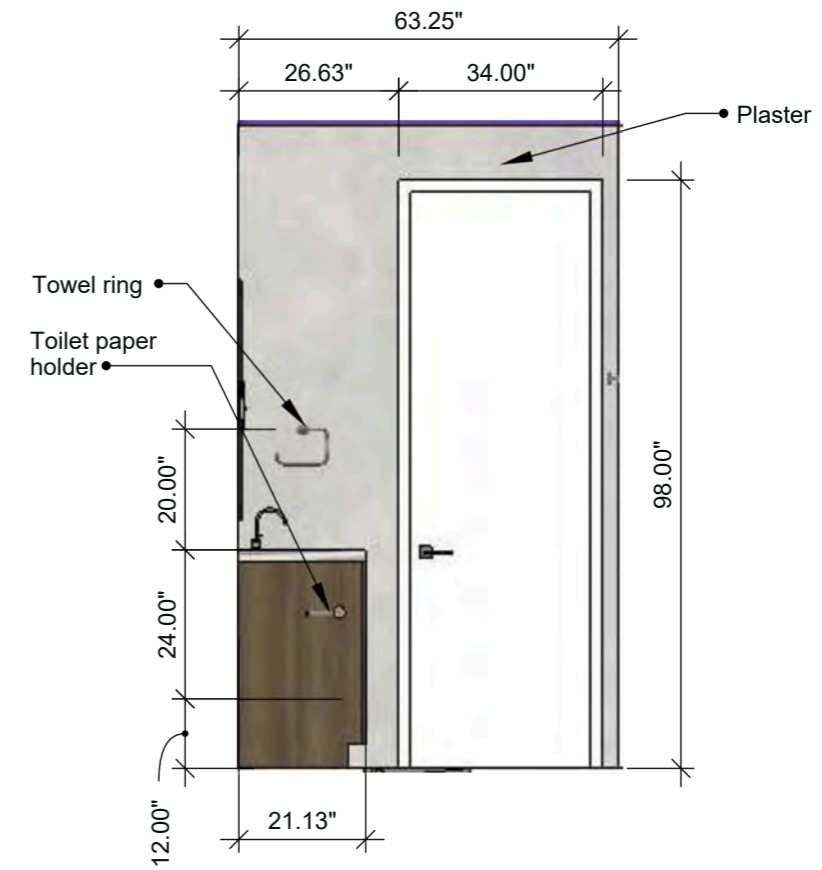

Bath 3 Elevation 2
SCALE: 3/8" = 1'-0" (1:32)

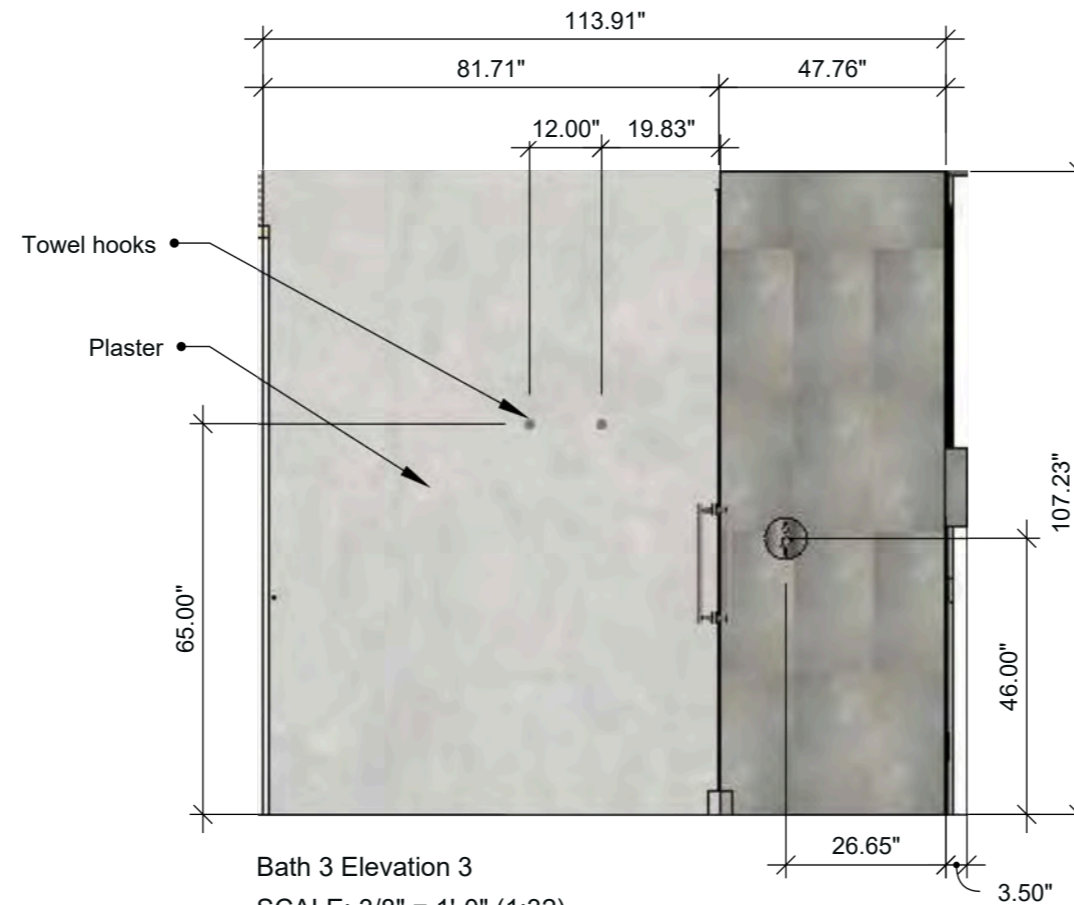

Bath 3 Elevation 3
SCALE: 3/8" = 1'-0" (1:32)

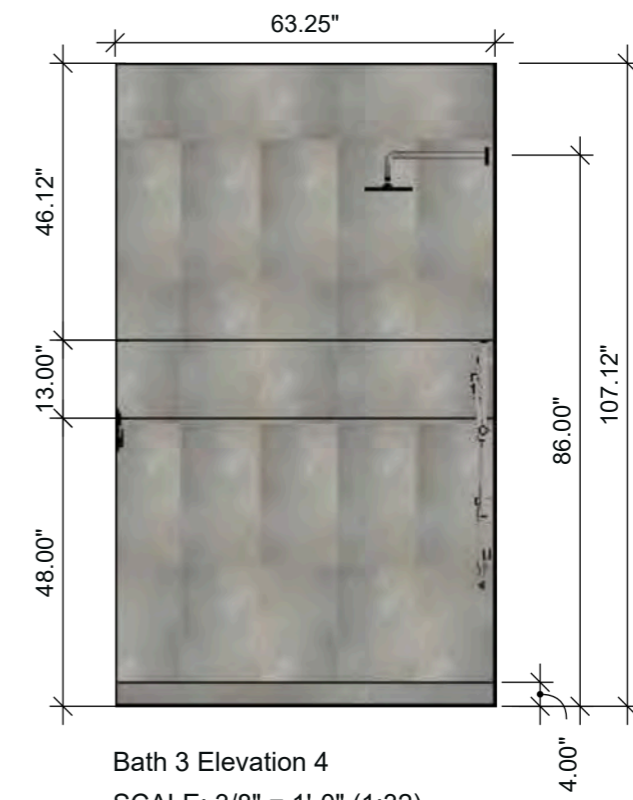

Bath 3 Elevation 4
SCALE: 3/8" = 1'-0" (1:32)

BATH 3 ELEVATIONS



ELYSSA CONTARDO DESIGNS
P // 760.579.8113
ELYSSA@ELYSSACONTARDO.COM

GENERAL NOTES:
WRITTEN DIMENSIONS SHALL TAKE PRECEDENCE OVER SCALED DIMENSIONS AND SHALL BE VERIFIED ON JOB SITE. ANY DISCREPANCY SHALL BE BROUGHT TO THE ATTENTION OF ELYSSA CONTARDO DESIGNS FOR CLARIFICATION BEFORE PROCEEDING WITH WORK. DRAWINGS TO BE USED IN CONSTRUCTION SHALL BE ARCHITECT DRAWINGS. ALL DIMENSIONS ARE BASED ON ARCHITECTURAL DRAWINGS. AS BUILT CONDITIONS MAY VARY.

DRAWING:
PROJECT:
2955 HERZOG COURT, PETALUMA, CA

REVISIONS	DESCRIPTION

SQ. FOOTAGE:
INTERIOR: -
EXTERIOR: -
TOTAL: -

DATE:
1-7-25
SCALE:
NTS
SHEET:
1-6

Shared Bath 1 & 2

MATERIALS

**PT-1
CEILING & WALLS**
PORTOLA PAINTS
LIMEWASH OR PLASTER
COLOR: PARLIAMENT

**STAIN - 1
DOORS**
MATCH TO DESIGNERS SAMPLE

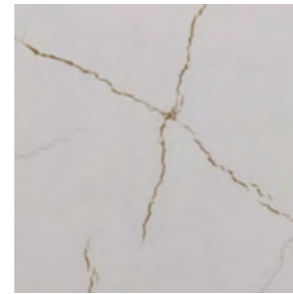

**CT-5
BROZINO**

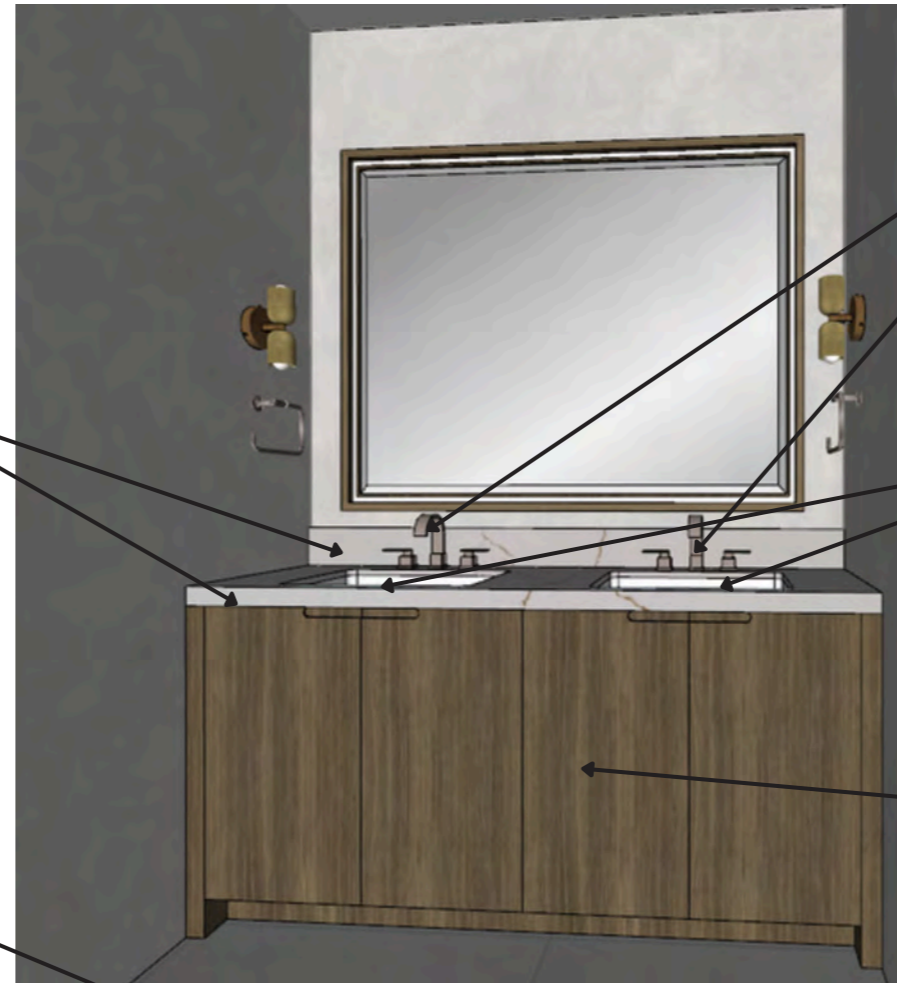

**P-?
FAUCET**
VIBRANT BRUSHED NICKEL
QTY:2



**P-?
SINK**
WHITE
QTY:2



**CAB-1
WOOD TYPE: ?**



**P-?
KOHLER**
VIBRANT
BRUSHED
NICKEL



**P-?
KOHLER**
VIBRANT
BRUSHED
NICKEL



**P-?
KOHLER**
VIBRANT
BRUSHED
NICKEL



**P-?
KOHLER**
VIBRANT
BRUSHED
NICKEL

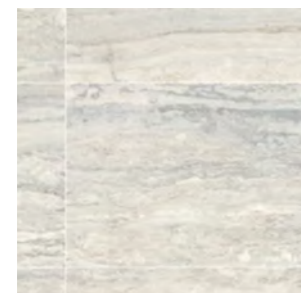

**WT-7
INVICTUS VEIN**
SIZE: 24"X48"

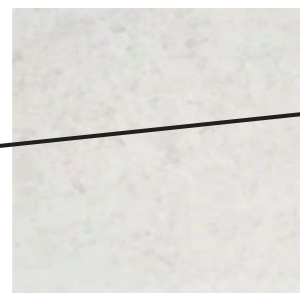

**FT-3
AGARWOOD LIMESTONE**
SIZE: 18"X36"

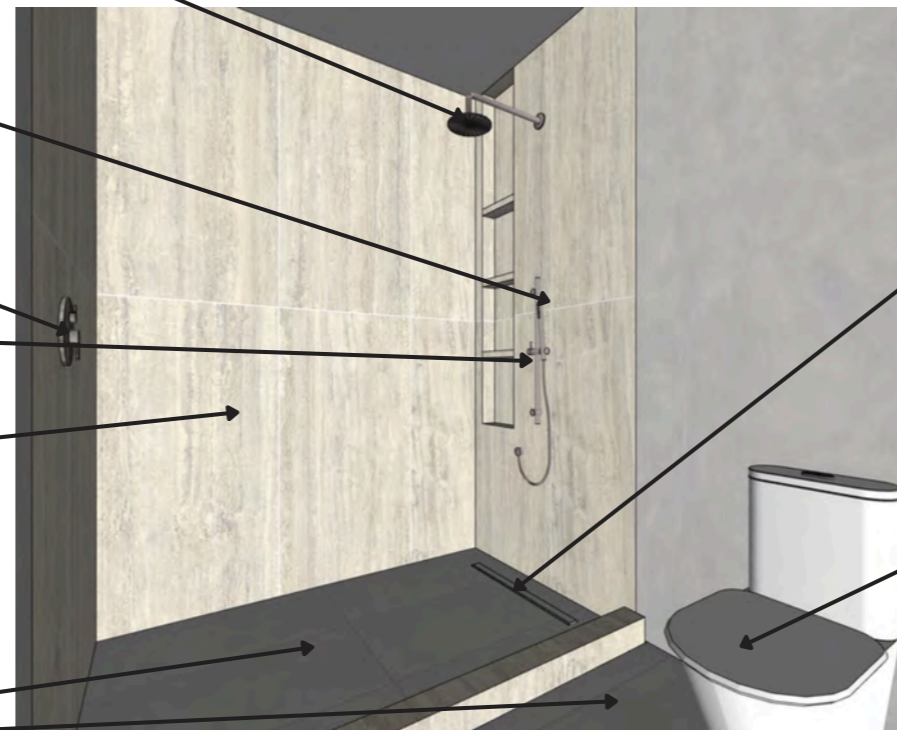

**P-?
LINEAR DRAIN**
SATIN STAINLESS STEEL



**PT-?
TOTO**
COTTON WHITE



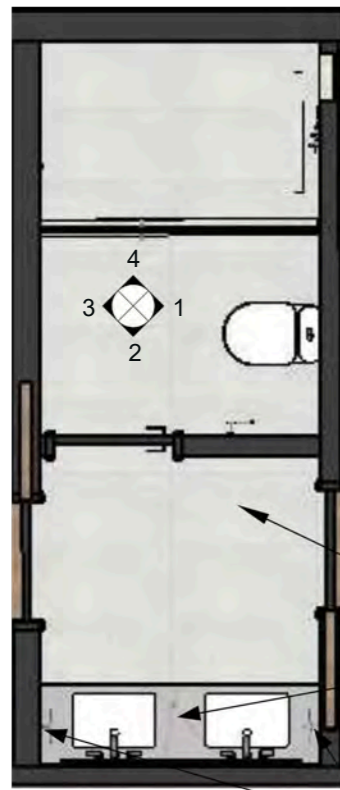

Shared Bath 1 & 2 Top View
SCALE: 1/4" = 1'-0" (1:48)

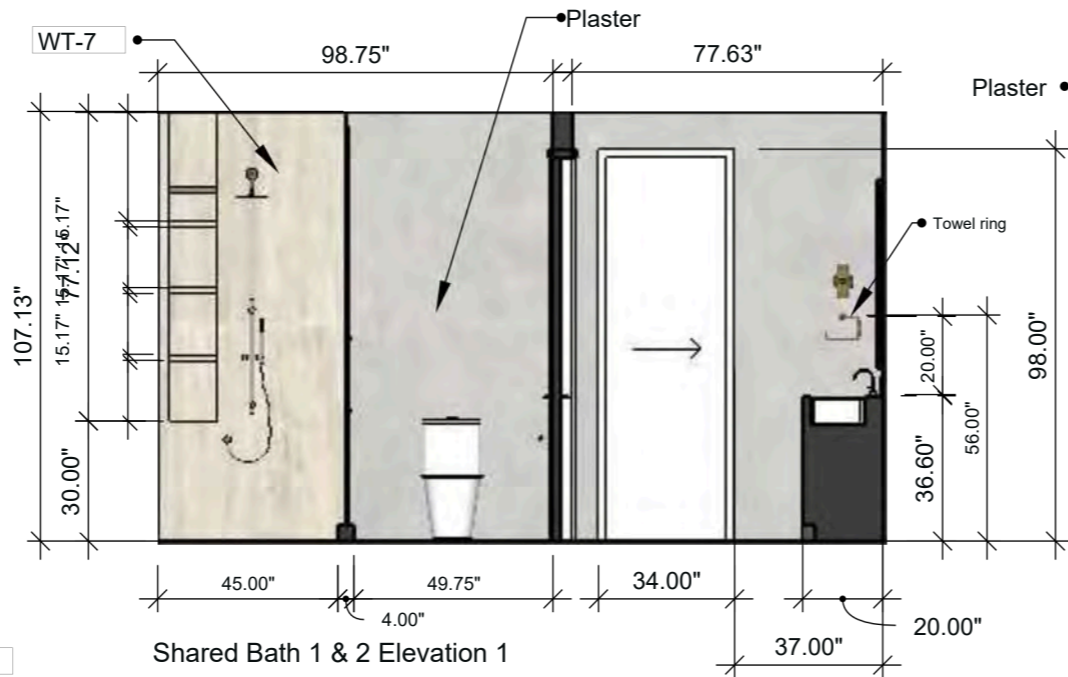

Shared Bath 1 & 2 Elevation 1
SCALE: 1/4" = 1'-0" (1:48)

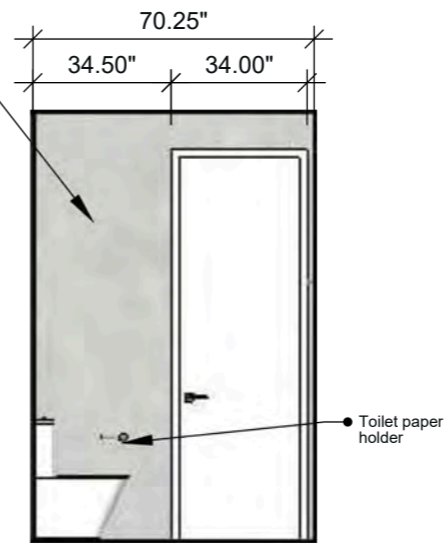

Shared Bath 1 & 2 Elevation 2
SCALE: 1/4" = 1'-0" (1:48)

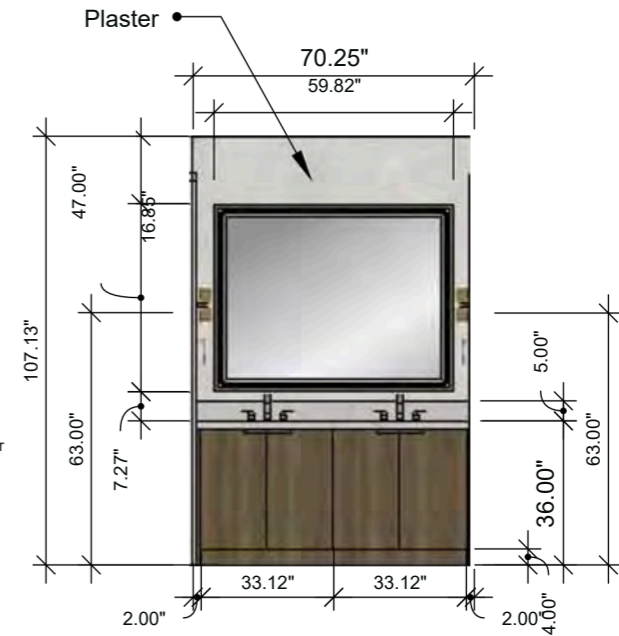

Shared Bath 1 & 2 Elevation 2.1
SCALE: 1/4" = 1'-0" (1:48)

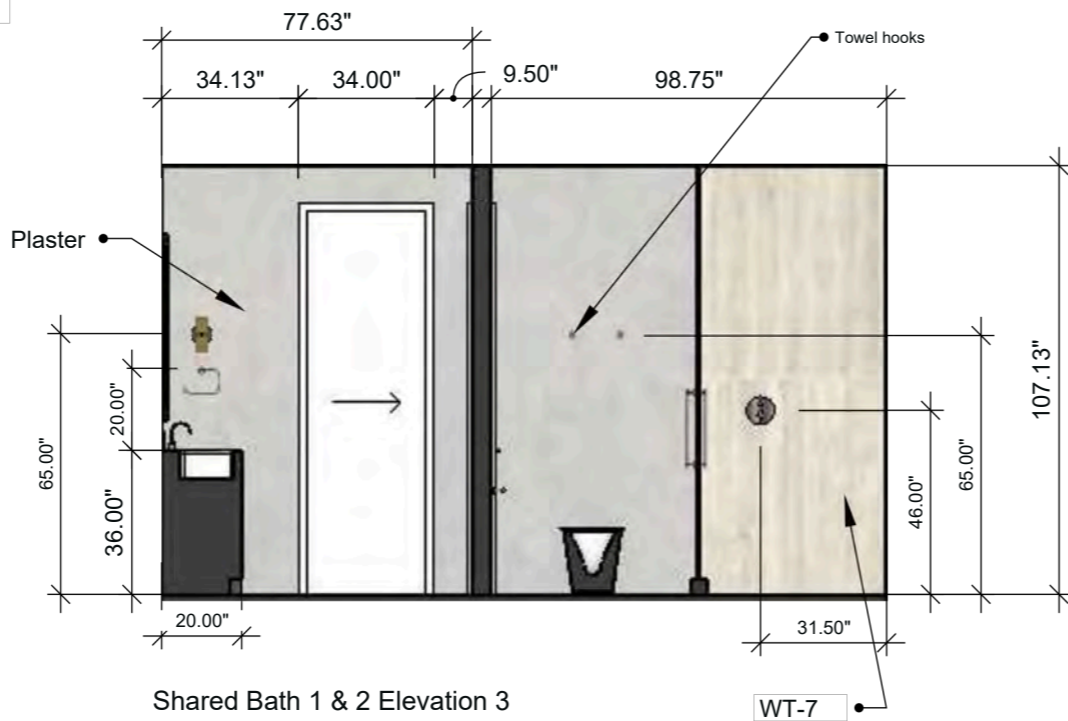

Shared Bath 1 & 2 Elevation 3
SCALE: 1/4" = 1'-0" (1:48)

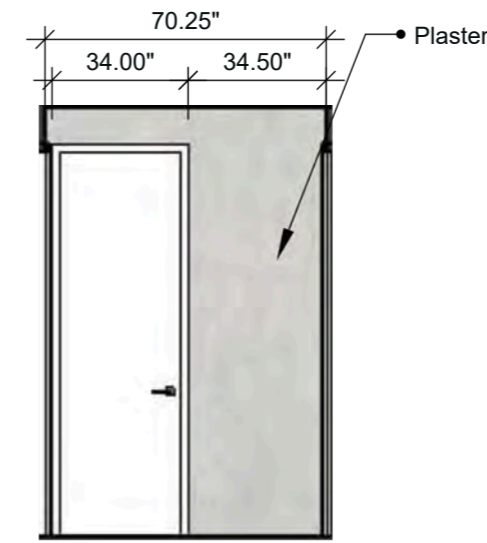

Shared Bath 1 & 2 Elevation 4
SCALE: 1/4" = 1'-0" (1:48)

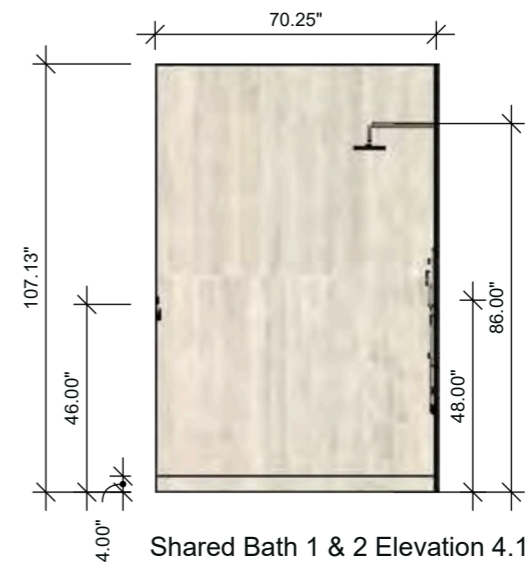

Shared Bath 1 & 2 Elevation 4.1
SCALE: 1/4" = 1'-0" (1:48)



ELYSSA CONTARDO DESIGNS
P// 760.579.8113
ELYSSA@ELYSSACONTARDO.COM

GENERAL NOTES:
WRITTEN DIMENSIONS SHALL TAKE PRECEDENCE OVER SCALED DIMENSIONS AND SHALL BE VERIFIED ON JOB SITE. ANY DISCREPANCY SHALL BE BROUGHT TO THE ATTENTION OF ELYSSA CONTARDO DESIGNS FOR CLARIFICATION BEFORE PROCEEDING WITH WORK. DRAWINGS TO BE USED IN CONSTRUCTION SHALL BE THE ARCHITECT'S DRAWINGS. ALL DIMENSIONS ARE BASED ON ARCHITECTURAL DRAWINGS AS BUILT CONDITIONS MAY VARY.

DRAWING: PROJECT:
2955 HERZOG COURT, PETALUMA, CA

REVISIONS	DESCRIPTION

SQ. FOOTAGE:
INTERIOR: -
EXTERIOR: -
TOTAL: -

DATE: 1-7-25
SCALE: NTS
SHEET: 1-7

SHARED BATH 1 & 2 ELEVATIONS

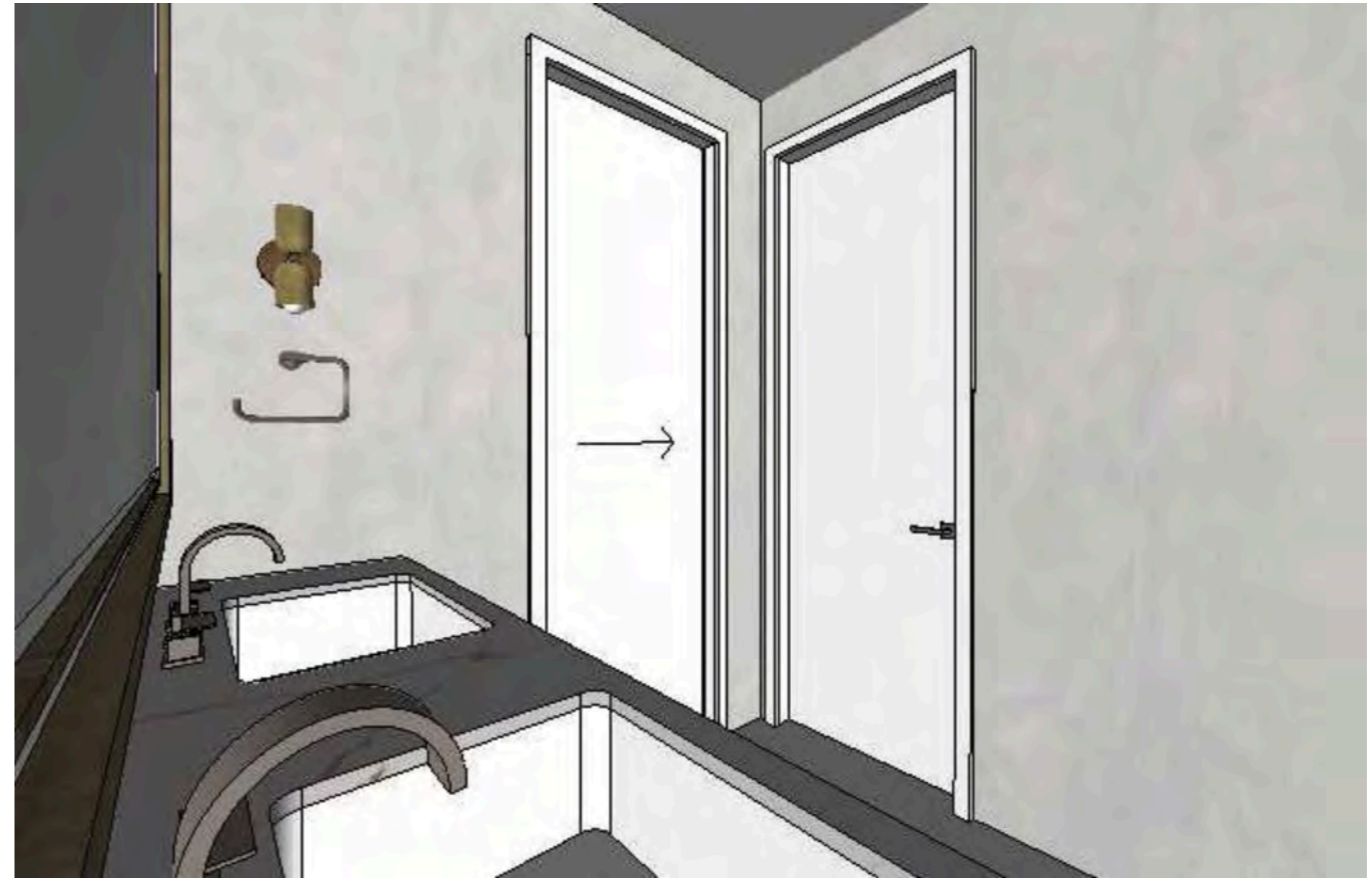
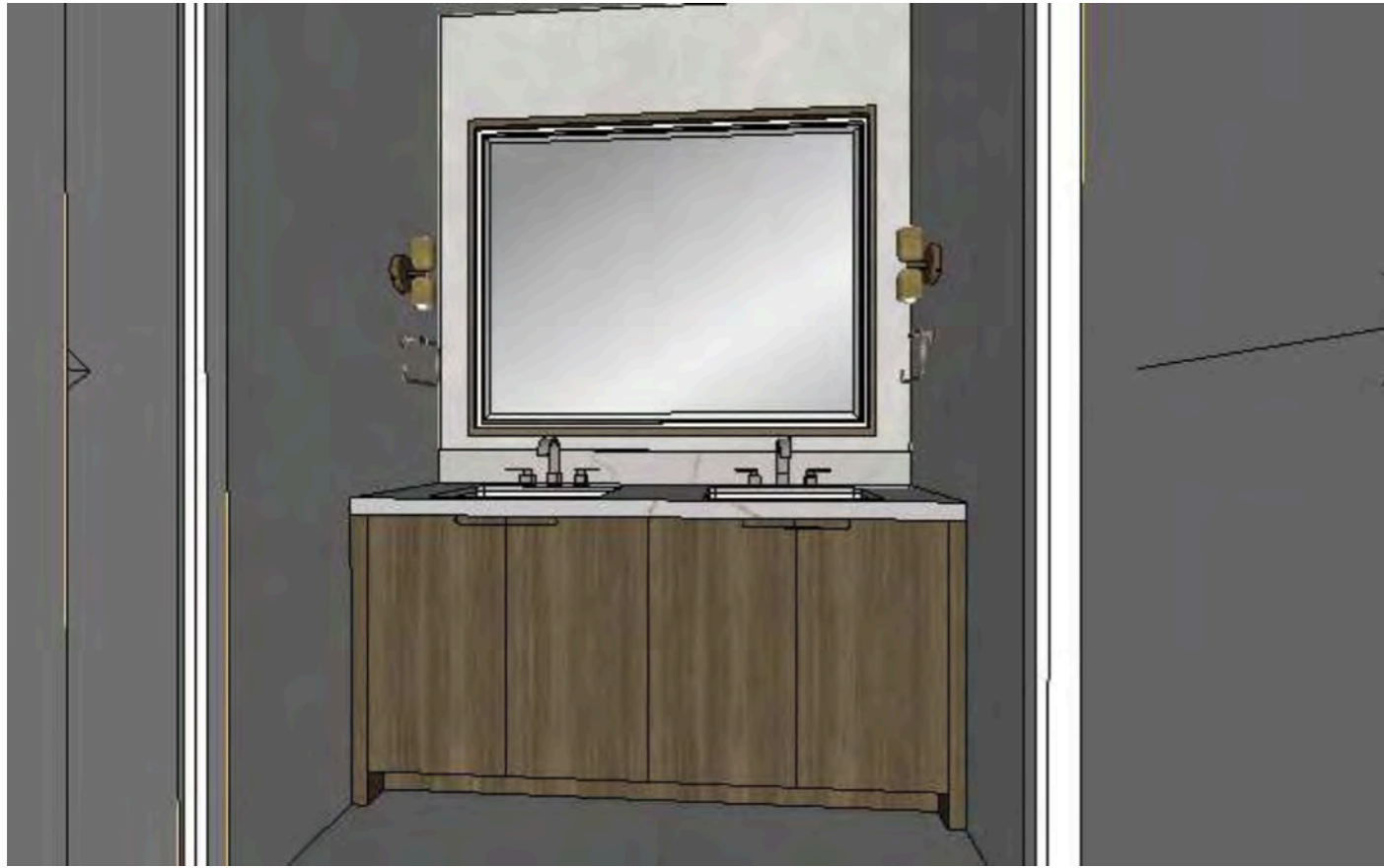

SHARED BATH 1 & 2 3D RENDERING



ELYSSA CONTARDO DESIGNS
P// 760.579.8113
ELYSSA@ELYSSACONTARDO.COM

GENERAL NOTES:
WRITTEN DIMENSIONS SHALL TAKE PRECEDENCE OVER SCALED DIMENSIONS AND SHALL BE VERIFIED ON JOB SITE. ANY DISCREPANCY SHALL BE BROUGHT TO THE ATTENTION OF ELYSSA CONTARDO DESIGNS FOR CLARIFICATION BEFORE PROCEEDING WITH WORK. DRAWINGS TO BE USED IN CONJUNCTION WITH ARCHITECT DRAWINGS. ALL DIMENSIONS ARE BASED ON ARCHITECTURAL DRAWINGS, AS BUILT CONDITIONS MAY VARY.

DRAWING:
PROJECT:
2955 HERZOG COURT, PETALUMA, CA

REVISIONS	DESCRIPTION

SQ. FOOTAGE:
INTERIOR: -
EXTERIOR: -
TOTAL: -
DATE:
1-7-25
SCALE:
NTS
SHEET:
1-7.1

Primary Bath

MATERIALS



CAB-1
WOOD TYPE: ?



PT-?
TOTO
COTTON WHITE



P-?
WATERMARK
PEWTER



P-?
WATERMARK
PEWTER



P-?
WATERMARK
PEWTER

PT-1
CEILING & WALLS
PORTOLA PAINTS
LIMEWASH OR PLASTER
COLOR: PARLIAMENT

STAIN - 1
DOORS
MATCH TO DESIGNERS SAMPLE

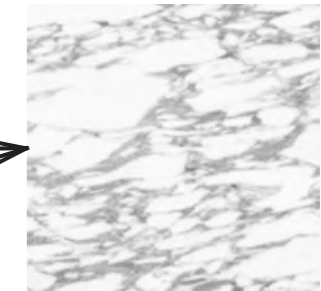

WS-9 & WS-10 & CT-8
CORCHIA MOON FACE



P-?
WATERMARK
PEWTER
QTY:2



P-?
KOHLER
WHITE
QTY:2



P-?
HYDRO SYSTEMS
WHITE
QTY:1



P-?
WATERMARK
PEWTER
QTY:1

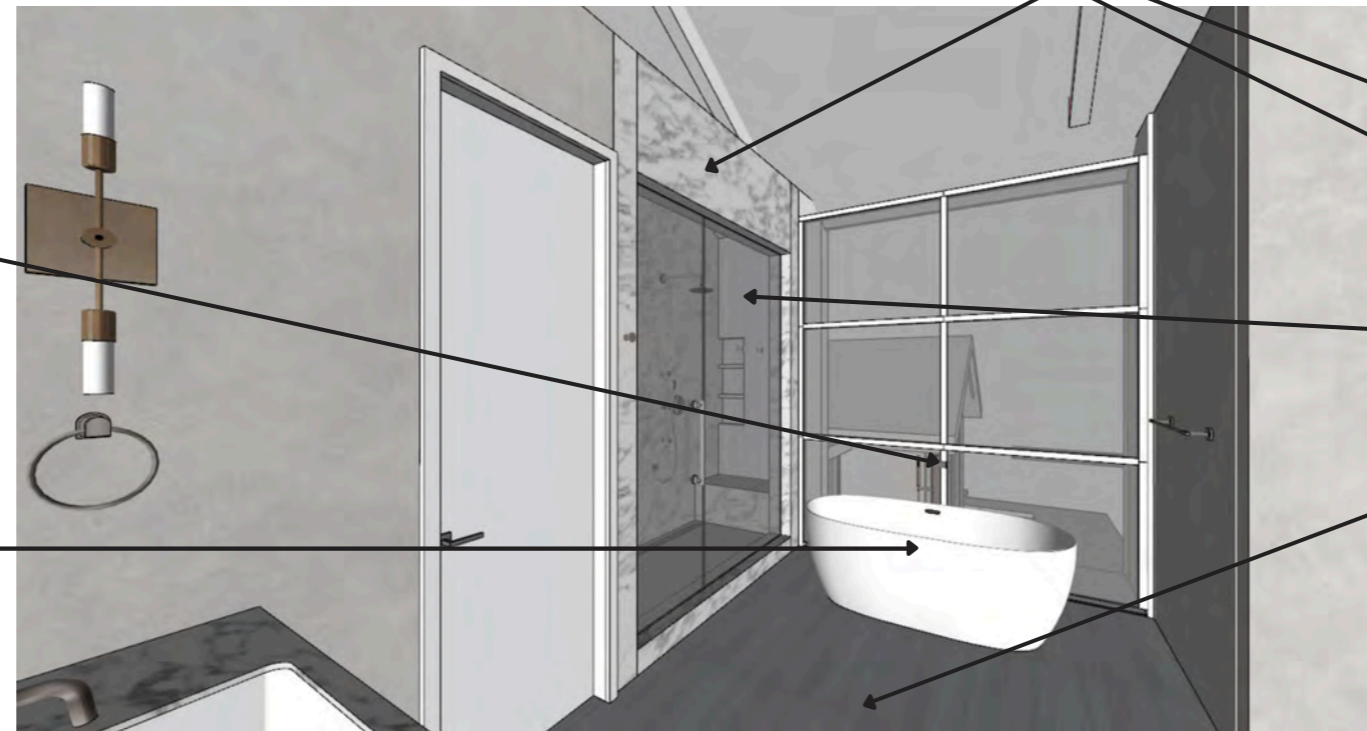

P-?
LINEAR DRAIN
GUNMETAL

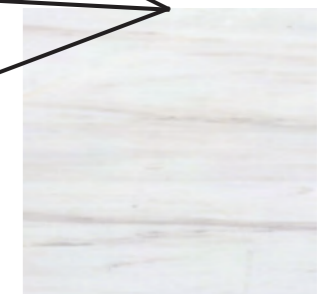

FT-6 & WT-11
DOLOMITE HONED
SIZE: 18"X36"



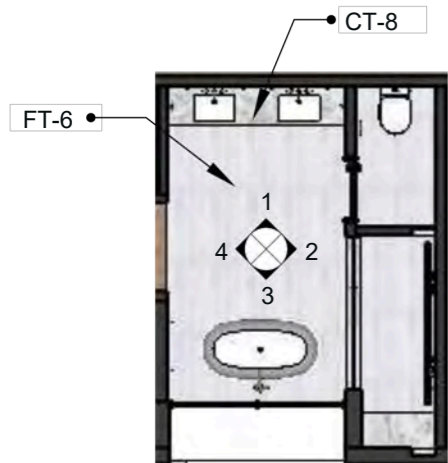

Primary Bath Top View
SCALE: 1/8" = 1'-0" (1:96)

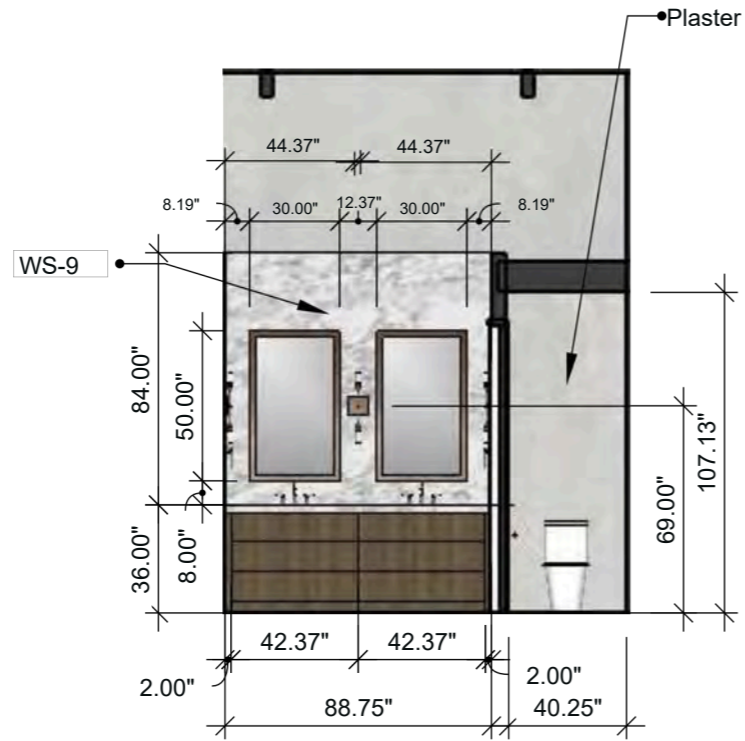

Primary Bath Elevation 1
SCALE: 3/16" = 1'-0" (1:64)

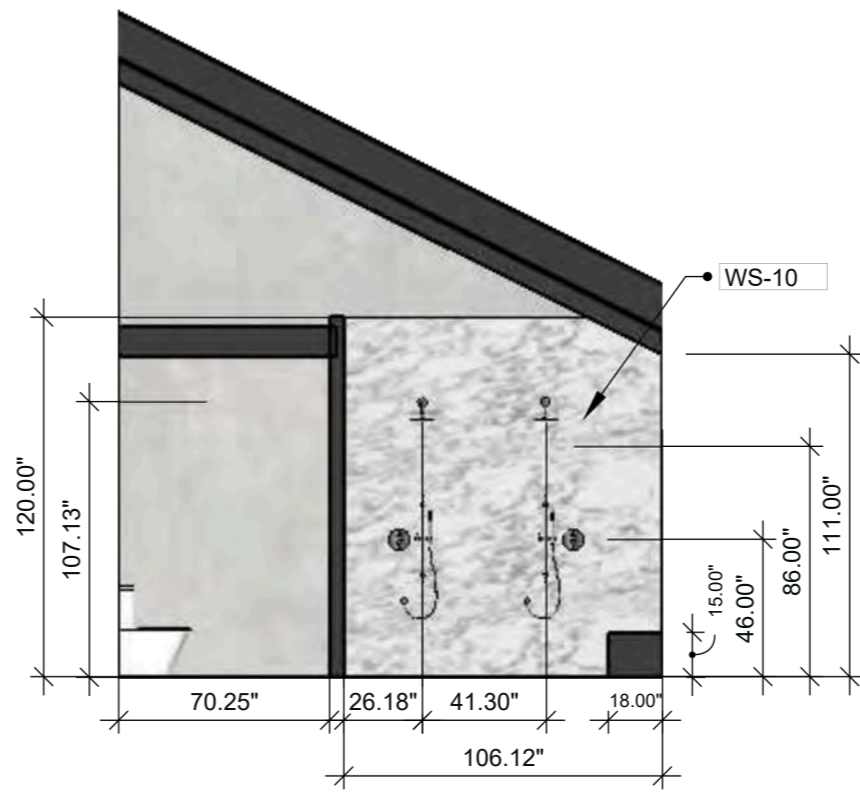

Primary Bath Elevation 2
SCALE: 3/16" = 1'-0" (1:64)

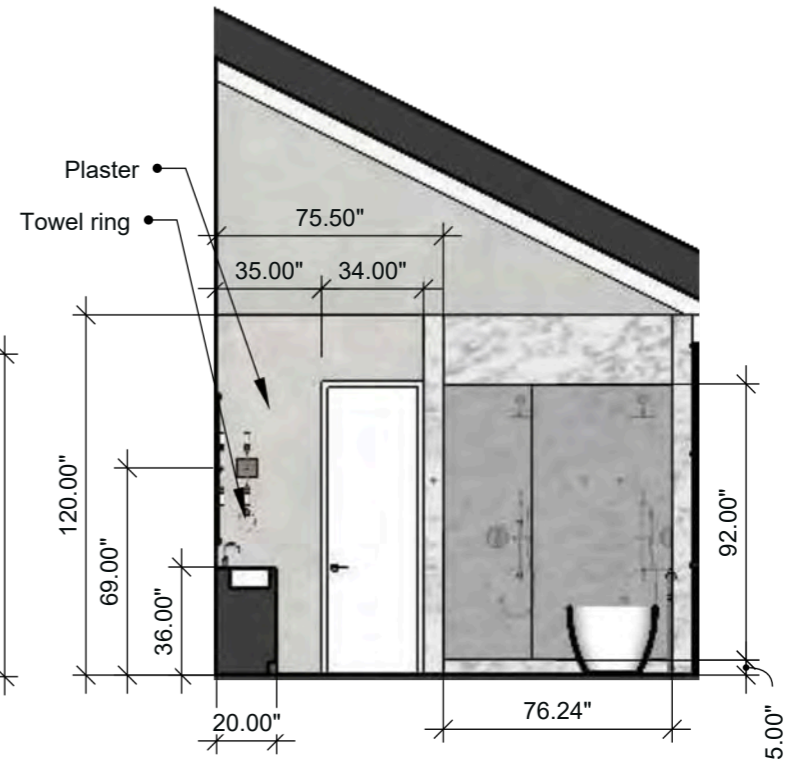

Primary Bath Elevation 2.1
SCALE: 3/16" = 1'-0" (1:64)

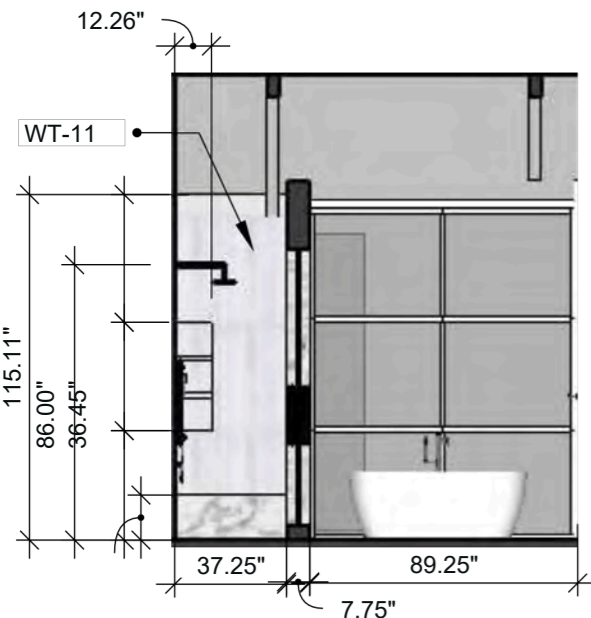

Primary Bath Elevation 3
SCALE: 3/16" = 1'-0" (1:64)

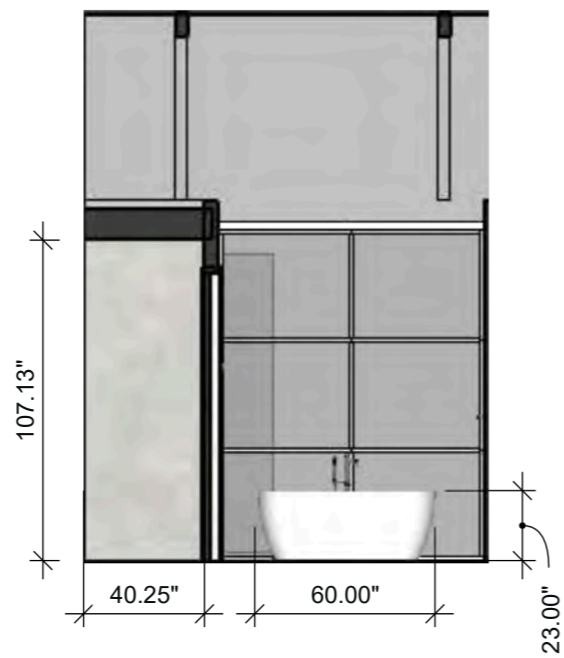

Primary Bath Elevation 3.1
SCALE: 3/16" = 1'-0" (1:64)

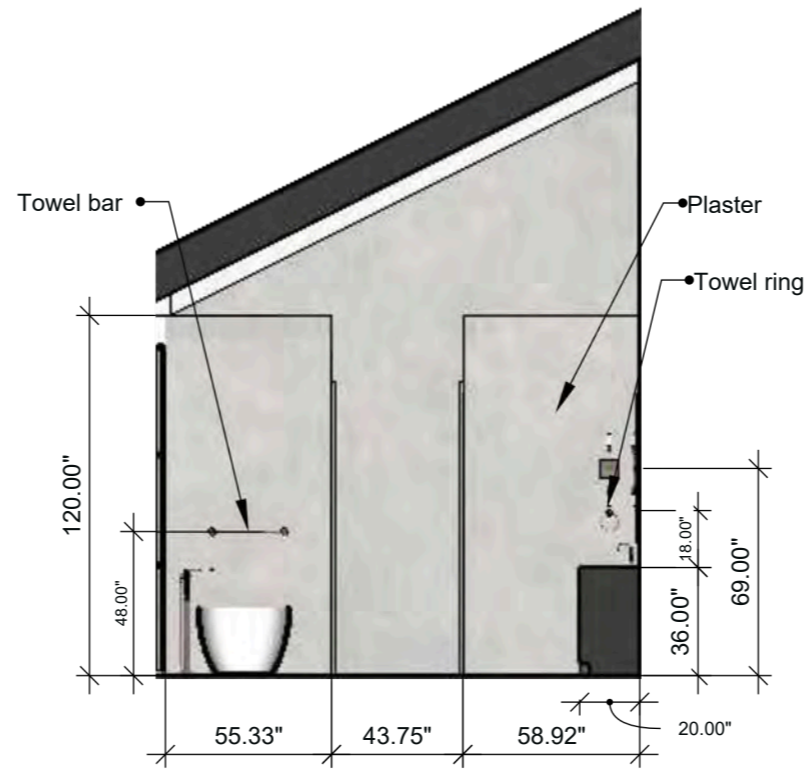

Primary Bath Elevation 4
SCALE: 3/16" = 1'-0" (1:64)

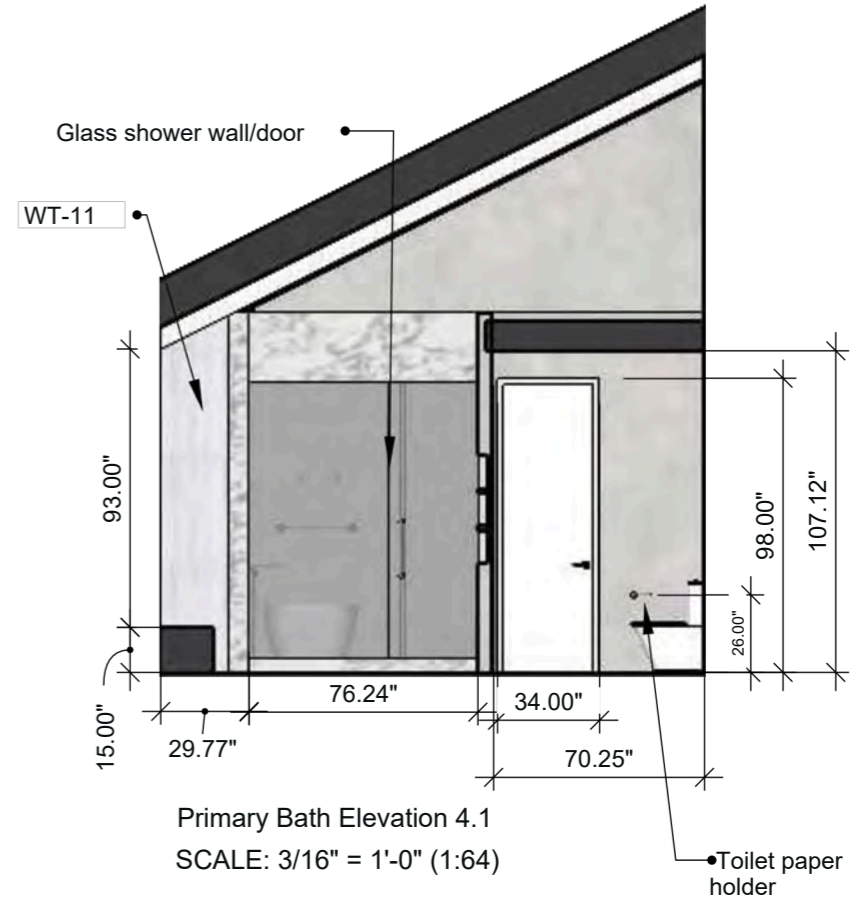

Primary Bath Elevation 4.1
SCALE: 3/16" = 1'-0" (1:64)

PRIMARY BATH ELEVATIONS



ELYSSA CONTARDO DESIGNS
P// 760.579.8113
ELYSSA@ELYSSACONTARDO.COM

GENERAL NOTES
WRITTEN DIMENSIONS SHALL TAKE PRECEDENCE OVER SCALED DIMENSIONS AND SHALL BE VERIFIED ON JOB SITE. ANY DISCREPANCY SHALL BE BROUGHT TO THE ATTENTION OF ELYSSA CONTARDO DESIGNS FOR CLARIFICATION BEFORE PROCEEDING WITH WORK. DRAWINGS TO BE USED IN CONJUNCTION WITH ARCHITECT DRAWINGS. ALL DIMENSIONS ARE BASED ON ARCHITECTURAL DRAWINGS AS BUILT CONDITIONS MAY VARY.

DRAWING:
PROJECT:
2955 HERZOG COURT, PETALUMA, CA

REVISIONS	DESCRIPTION

SQ. FOOTAGE:
INTERIOR: -
EXTERIOR: -
TOTAL: -
DATE: 1-7-25
SCALE: NTS
SHEET: 1-8



PRIMARY BATH 3D RENDERING



ELYSSA CONTARDO DESIGNS
P // 760.579.8113
ELYSSA@ELYSSACONTARDO.COM

GENERAL NOTES:
WRITTEN DIMENSIONS SHALL TAKE PRECEDENCE OVER SCALED DIMENSIONS AND SHALL BE VERIFIED ON JOB SITE. ANY DISCREPANCY SHALL BE BROUGHT TO THE ATTENTION OF ELYSSA CONTARDO DESIGNS FOR CLARIFICATION BEFORE PROCEEDING WITH WORK. DRAWINGS TO BE USED IN CONJUNCTION WITH ARCHITECT DRAWINGS. ELEVATION DIMENSIONS ARE BASED ON ARCHITECTURAL DRAWINGS AS BUILT CONDITIONS MAY VARY.

DRAWING:
PROJECT:
2955 HERZOG COURT, PETALUMA, CA

REVISIONS	DESCRIPTION

SQ. FOOTAGE:
INTERIOR: -
EXTERIOR: -
TOTAL: -

DATE:
1-7-25
SCALE:
NTS
SHEET:
I-8.1

Pool House Powder

MATERIALS

PT-1
CEILINGS & WALLS
PORTOLA PAINTS
LIMEWASH OR PLASTER
COLOR: PARLIAMENT

STAIN - 1
DOORS
MATCH TO DESIGNERS SAMPLE



CT-3
TITANIUM TRAVERTINE
VANITY WITH
INTEGRATED SINK

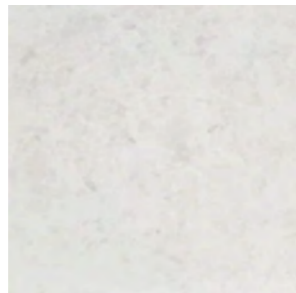

FT-2
AGARWOOD LIMESTONE
SIZE: 18" X 36"



P-?
FAUCET
VIBRANT BRUSHED NICKEL



PT-?
TOTO
COTTON WHITE



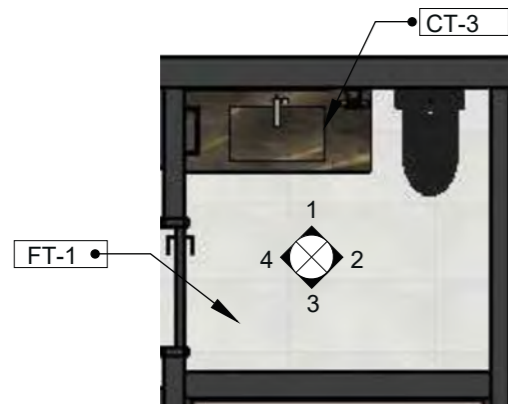

Pool House Powder Top View
SCALE: 1/4" = 1'-0" (1:48)

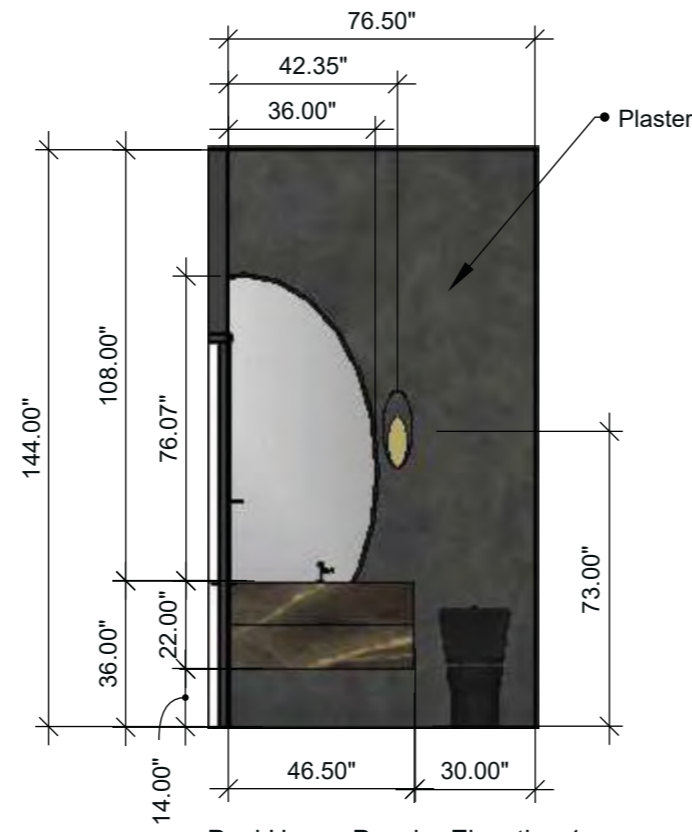

Pool House Powder Elevation 1
SCALE: 1/4" = 1'-0" (1:48)

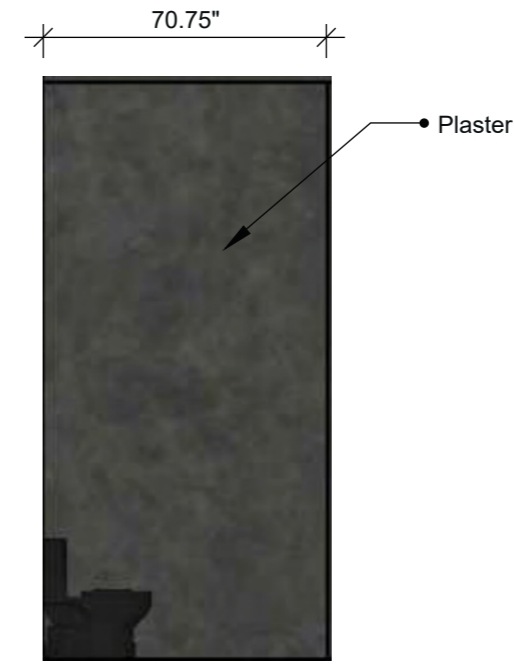

Pool House Powder Elevation 2
SCALE: 1/4" = 1'-0" (1:48)

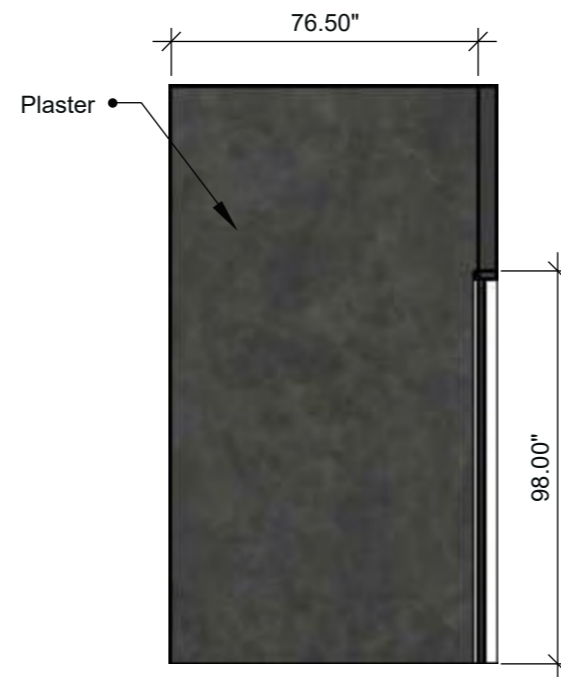

Pool House Powder Elevation 3
SCALE: 1/4" = 1'-0" (1:48)

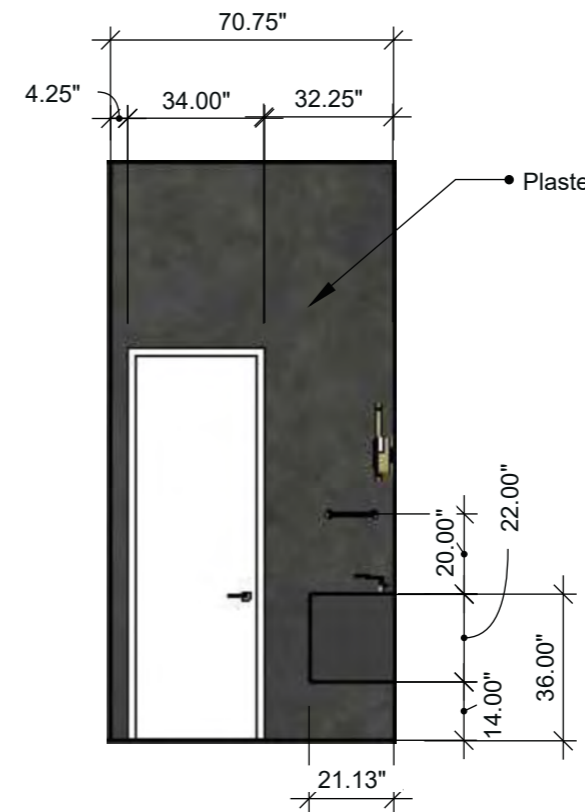

Pool House Powder Elevation 4
SCALE: 1/4" = 1'-0" (1:48)

POOL HOUSE POWDER ELEVATIONS



ELYSSA CONTARDO DESIGNS
P// 760.579.8113
ELYSSA@ELYSSACONTARDO.COM

GENERAL NOTES
WRITTEN DIMENSIONS SHALL TAKE PRECEDENCE OVER SCALED DIMENSIONS AND SHALL BE VERIFIED ON JOB SITE. ANY DISCREPANCY SHALL BE BROUGHT TO THE ATTENTION OF ELYSSA CONTARDO DESIGNS FOR CLARIFICATION BEFORE PROCEEDING WITH WORK. DRAWINGS TO BE USED IN CONJUNCTION WITH ARCHITECT DRAWINGS. ALL DIMENSIONS ARE BASED ON ARCHITECTURAL DRAWINGS AS BUILT CONDITIONS MAY VARY.

DRAWING:

PROJECT:
2955 HERZOG COURT, PETALUMA, CA

REVISIONS	DESCRIPTION

SQ. FOOTAGE:
INTERIOR: -
EXTERIOR: -
TOTAL: -

DATE:
1-7-25
SCALE:
NTS

SHEET:
1-9

Pool House Kitchenette

MATERIALS

**PT-1
CEILINGS & WALLS**
PORTOLA PAINTS
LIMEWASH OR PLASTER
COLOR: PARLIAMENT

**STAIN - 1
DOORS**
MATCH TO DESIGNERS SAMPLE



**P-?
FAUCET**
SATIN NICKEL



**P-?
SINK**
SATIN POLISH



CAB-1
WOOD TYPE: ?

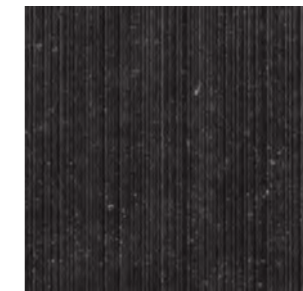

WT-5
BLUEBELGE
SIZE: 12"X24"

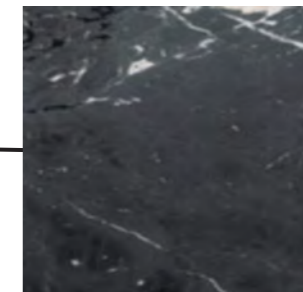

CT-4
NEGRESSO BLACK

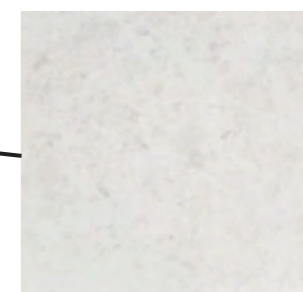

FT-2
AGARWOOD LIMESTONE
SIZE: 18"X36"





ELYSSA CONTARDO DESIGNS
 P// 760.579.8113
 ELYSSA@ELYSSACONTARDO.COM

GENERAL NOTES
 WRITTEN DIMENSIONS SHALL TAKE PRECEDENCE OVER SCALED DIMENSIONS AND SHALL BE VERIFIED ON JOB SITE. ANY DISCREPANCY SHALL BE BROUGHT TO THE ATTENTION OF ELYSSA CONTARDO DESIGNS FOR CLARIFICATION BEFORE PROCEEDING WITH WORK. DRAWINGS TO BE USED IN CONSTRUCTION SHALL BE THE ARCHITECT'S DRAWINGS. ALL DIMENSIONS ARE BASED ON ARCHITECTURAL DRAWINGS AS BUILT CONDITIONS MAY VARY.

DRAWING:

PROJECT:

2955 HERZOG COURT, PETALUMA, CA

REVISIONS	DESCRIPTION

SQ. FOOTAGE:
 INTERIOR: -
 EXTERIOR: -
 TOTAL: -

DATE: 1-7-25
 SCALE: NTS
 SHEET: I-10

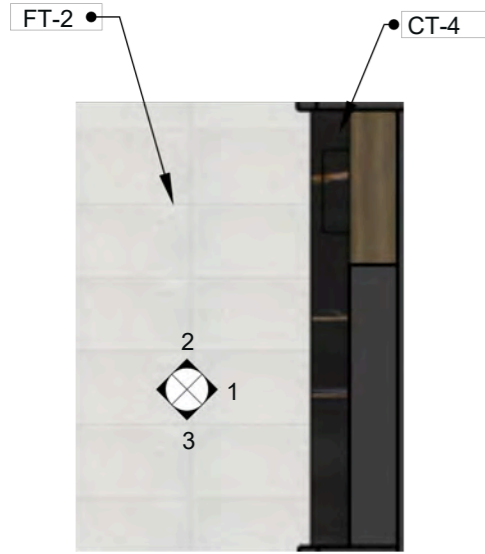

Pool House Kitchenette Top View
 SCALE: 1/4" = 1'-0" (1:48)

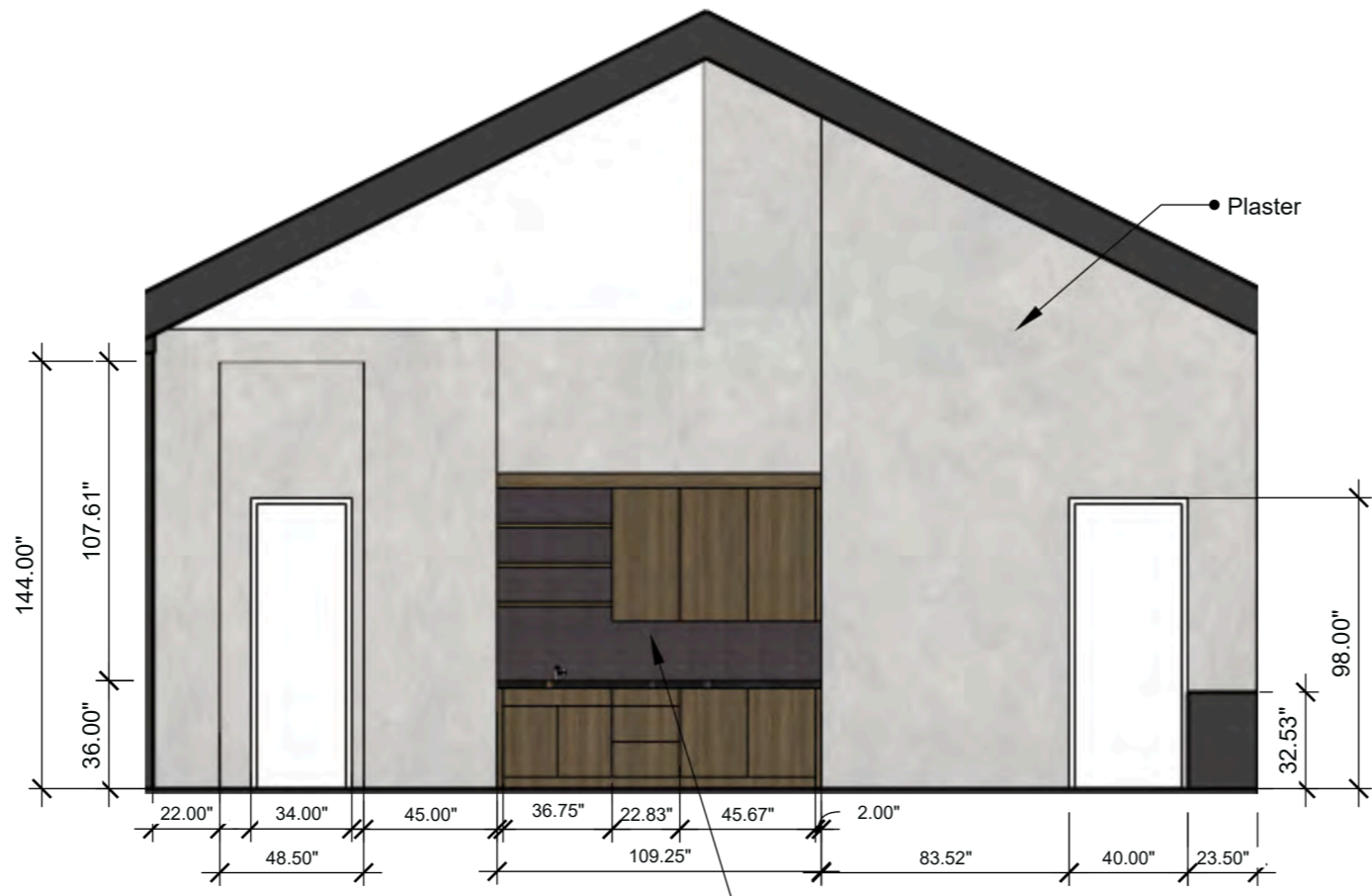

Pool House Kitchenette Elevation 1
 SCALE: 3/16" = 1'-0" (1:64)

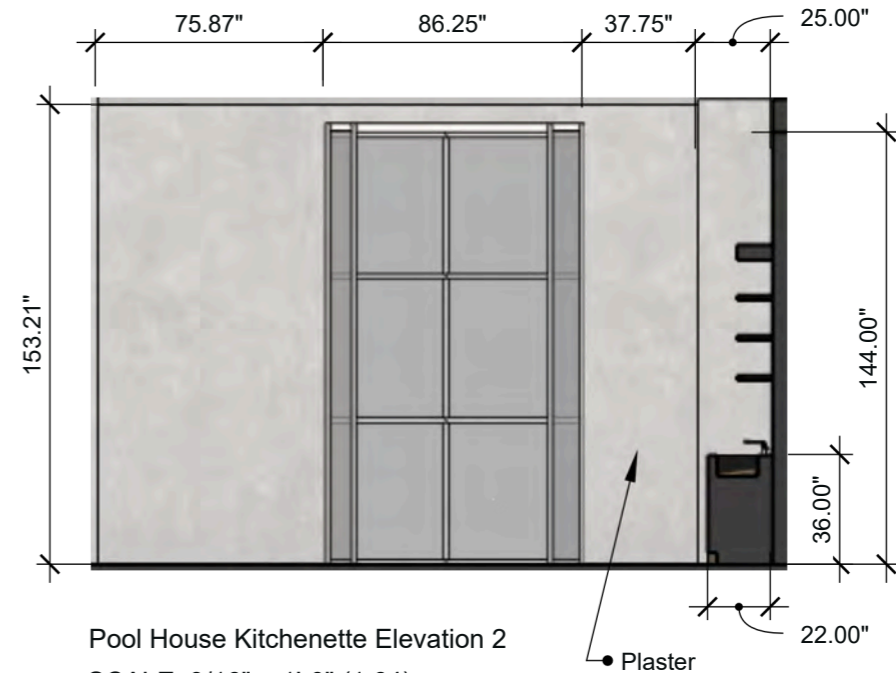

Pool House Kitchenette Elevation 2
 SCALE: 3/16" = 1'-0" (1:64)

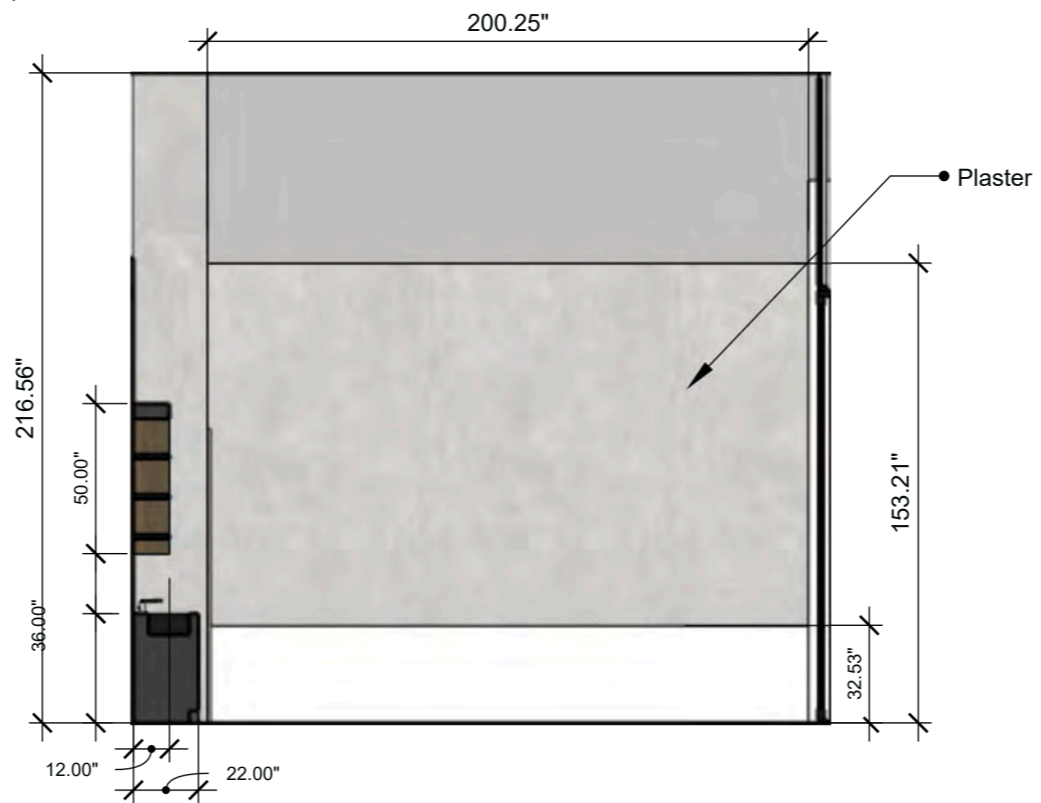

Pool House Kitchenette Elevation 3
 SCALE: 3/16" = 1'-0" (1:64)

POOL HOUSE KITCHENETTE ELEVATIONS

Pool House Bath

MATERIALS

PT-1
CEILINGS & WALLS
 PORTOLA PAINTS
 LIMEWASH OR PLASTER
 COLOR: PARLIAMENT

STAIN - 1
DOORS
 MATCH TO DESIGNERS SAMPLE

P-?
KOHLER
 VIBRANT
 BRUSHED
 NICKEL

P-?
KOHLER
 VIBRANT
 BRUSHED
 NICKEL

P-?
KOHLER
 VIBRANT
 BRUSHED
 NICKEL



WT-5
SAVANA NATTE
 SIZE: 12"X24"



P-?
KOHLER
 VIBRANT
 BRUSHED
 NICKEL



P-?
LINEAR DRAIN
 SATIN STAINLESS STEEL



P-?
FAUCET
 VIBRANT BRUSHED NICKEL
 QTY:2

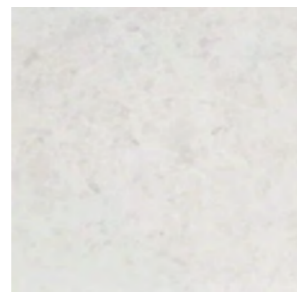

FT-2
AGARWOOD LIMESTONE
 SIZE: 18"X36"



PT-?
TOTO
 COTTON WHITE



CAB-1
 WOOD TYPE: ?



P-?
SINK
 WHITE
 QTY:2

CT-?





ELYSSA CONTARDO DESIGNS
 P // 760.579.8113
 ELYSSA@ELYSSACONTARDO.COM

GENERAL NOTES
 WRITTEN DIMENSIONS SHALL TAKE PRECEDENCE OVER SCALED DIMENSIONS AND SHALL BE VERIFIED ON JOB SITE. ANY DISCREPANCY SHALL BE BROUGHT TO THE ATTENTION OF ELYSSA CONTARDO DESIGNS FOR CLARIFICATION BEFORE PROCEEDING WITH WORK. DRAWINGS TO BE USED IN CONSTRUCTION WITH ARCHITECT DRAWINGS. ALL DIMENSIONS ARE BASED ON ARCHITECTURAL DRAWINGS AS BUILT CONDITIONS MAY VARY.

DRAWING:
PROJECT: 2955 HERZOG COURT, PETALUMA, CA

REVISIONS	DESCRIPTION

SQ. FOOTAGE:
 INTERIOR: -
 EXTERIOR: -
 TOTAL: -

DATE: 1-7-25
SCALE: NTS
SHEET: I-11

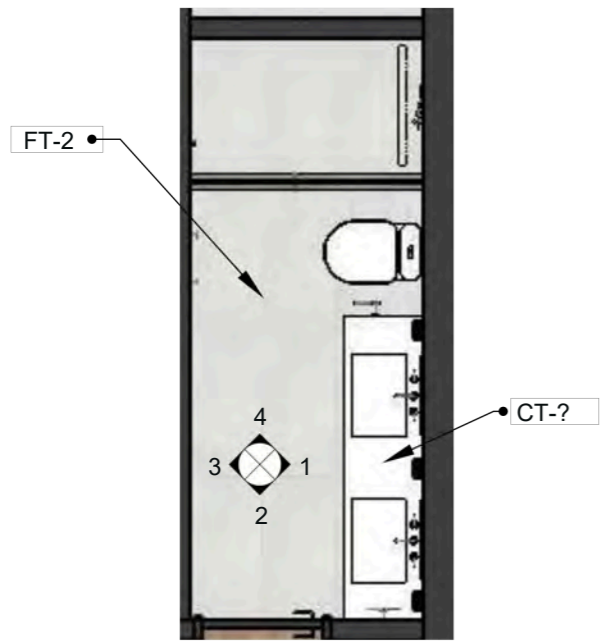

Pool House Bath Top View
 SCALE: 1/4" = 1'-0" (1:48)

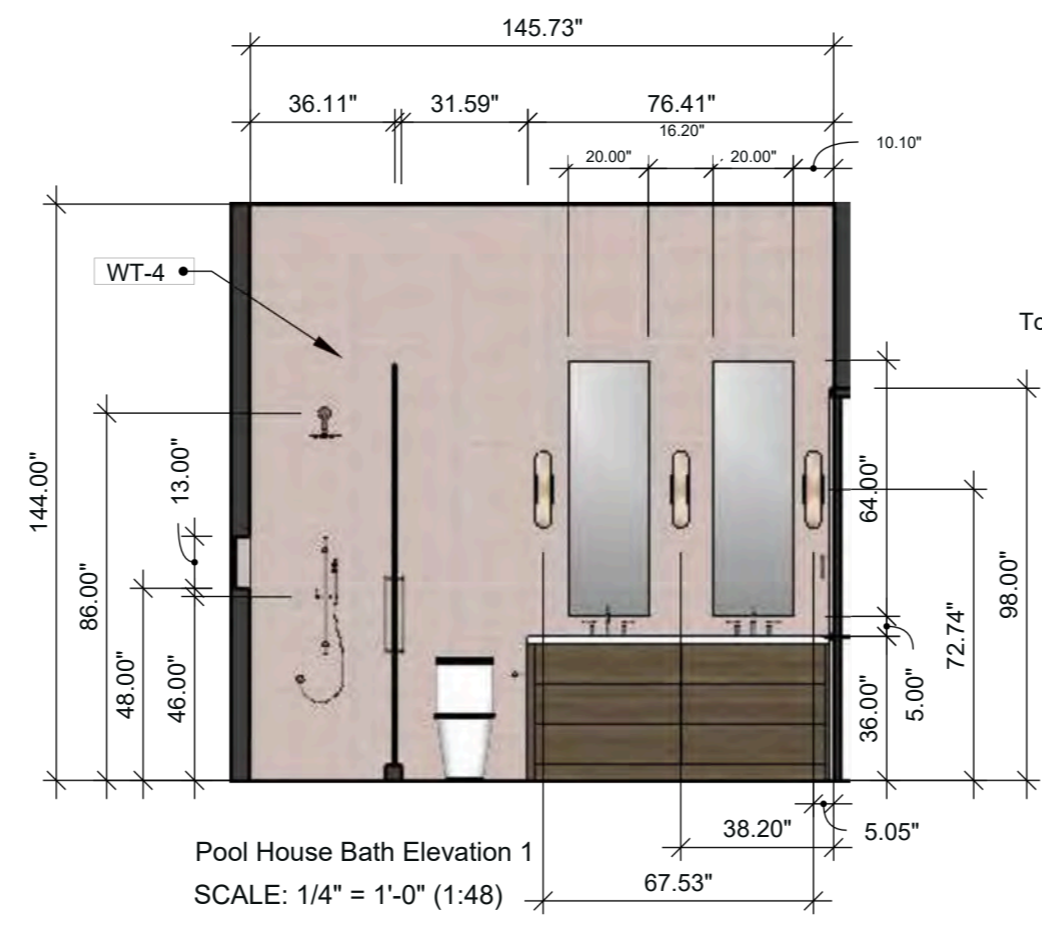

Pool House Bath Elevation 1
 SCALE: 1/4" = 1'-0" (1:48)

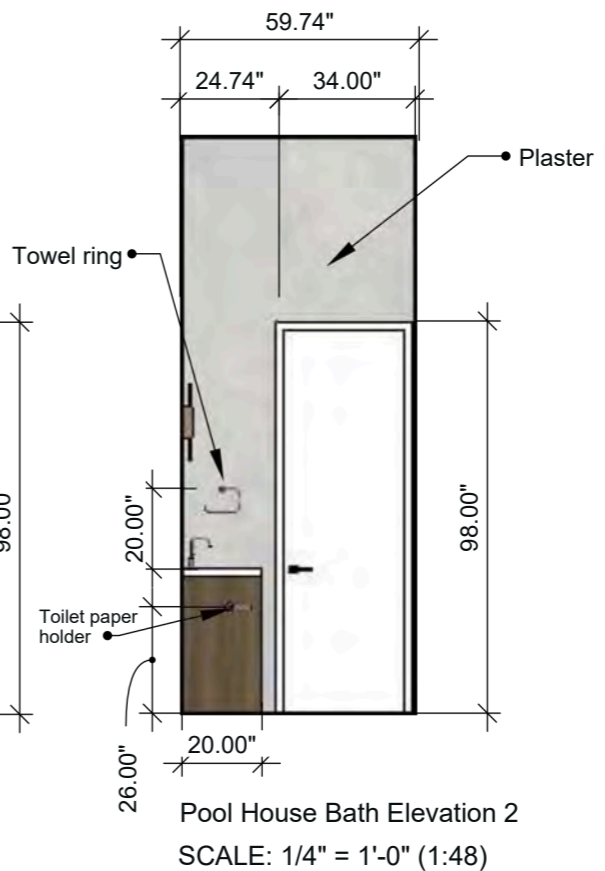

Pool House Bath Elevation 2
 SCALE: 1/4" = 1'-0" (1:48)

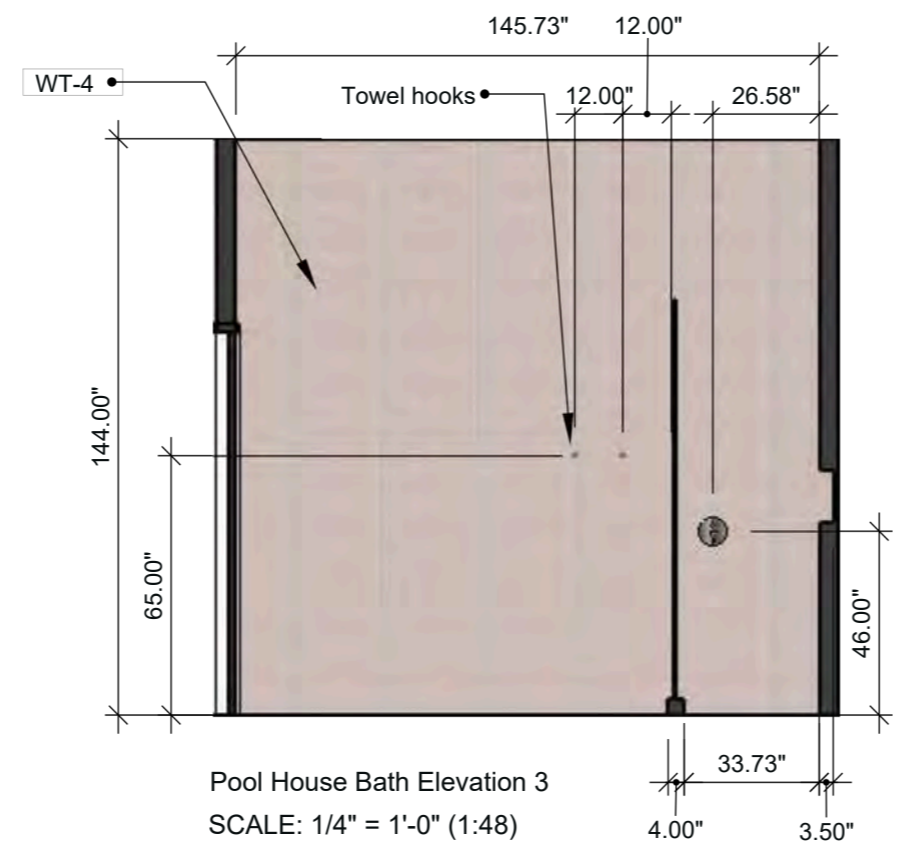

Pool House Bath Elevation 3
 SCALE: 1/4" = 1'-0" (1:48)

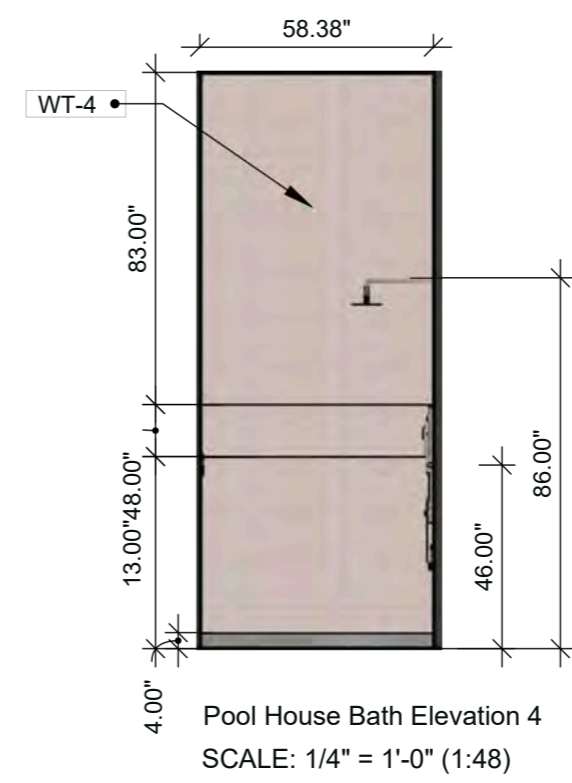

Pool House Bath Elevation 4
 SCALE: 1/4" = 1'-0" (1:48)

POOL HOUSE BATH ELEVATIONS



POOL HOUSE BATH 3D RENDERING



ELYSSA CONTARDO DESIGNS
 P// 760.579.8113
 ELYSSA@ELYSSACONTARDO.COM

GENERAL NOTES
 WRITTEN DIMENSIONS SHALL TAKE PRECEDENCE OVER SCALED DIMENSIONS AND SHALL BE VERIFIED ON JOB SITE. ANY DISCREPANCY SHALL BE BROUGHT TO THE ATTENTION OF ELYSSA CONTARDO DESIGNS FOR CLARIFICATION BEFORE PROCEEDING WITH WORK. DRAWINGS TO BE USED IN CONSULTATION WITH ARCHITECT DRAWINGS. ALL DIMENSIONS ARE BASED ON ARCHITECTURAL DRAWINGS AS BUILT CONDITIONS MAY VARY.

DRAWING:
PROJECT:
 2955 HERZOG COURT, PETALUMA, CA

REVISIONS	DESCRIPTION

SQ. FOOTAGE:
 INTERIOR: -
 EXTERIOR: -
 TOTAL: -

DATE:
 1-7-25

SCALE:
 NTS

SHEET:
 I-11.1

Outdoor Bath

MATERIALS

PT-1
CEILINGS & WALLS
PORTOLA PAINTS
LIMEWASH OR PLASTER
COLOR: PARLIAMENT

STAIN - 1
DOORS
MATCH TO DESIGNERS SAMPLE

P-?
KOHLER
VIBRANT
BRUSHED
NICKEL

P-?
KOHLER
VIBRANT
BRUSHED
NICKEL

P-?
KOHLER
VIBRANT
BRUSHED
NICKEL



P-?
KOHLER
VIBRANT
BRUSHED
NICKEL



P-?
LINEAR DRAIN
SATIN STAINLESS STEEL



WT-?



P-?
FAUCET
VIBRANT BRUSHED NICKEL



P-?
SINK
WHITE

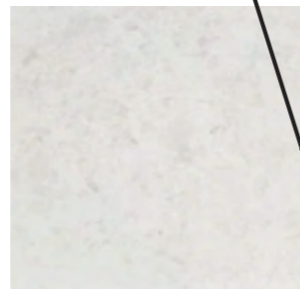

FT-7
HONED AGARWOOD
LIMESTONE
SIZE: 18" X 36"



PT-?
TOTO
COTTON WHITE

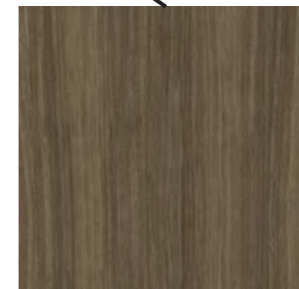

CAB-1
WOOD TYPE: ?

CT-?





ELYSSA CONTARDO DESIGNS
P// 760.579.8113
ELYSSA@ELYSSACONTARDO.COM

GENERAL NOTES:
WRITTEN DIMENSIONS SHALL TAKE PRECEDENCE OVER SCALED DIMENSIONS AND SHALL BE VERIFIED ON JOB SITE. ANY DISCREPANCY SHALL BE BROUGHT TO THE ATTENTION OF ELYSSA CONTARDO DESIGNS FOR CLARIFICATION BEFORE PROCEEDING WITH WORK. DRAWINGS TO BE USED IN CONJUNCTION WITH ARCHITECT DRAWINGS. ELEVATION DIMENSIONS ARE BASED ON ARCHITECTURAL DRAWINGS. AS BUILT CONDITIONS MAY VARY.

DRAWING:

PROJECT:
2955 HERZOG COURT, PETALUMA, CA

REVISIONS	DESCRIPTION

SQ. FOOTAGE:
INTERIOR: -
EXTERIOR: -
TOTAL: -

DATE:
1-7-25
SCALE:
NTS
SHEET:

I-12



Outdoor Bath Top View
SCALE: 1/4" = 1'-0" (1:48)

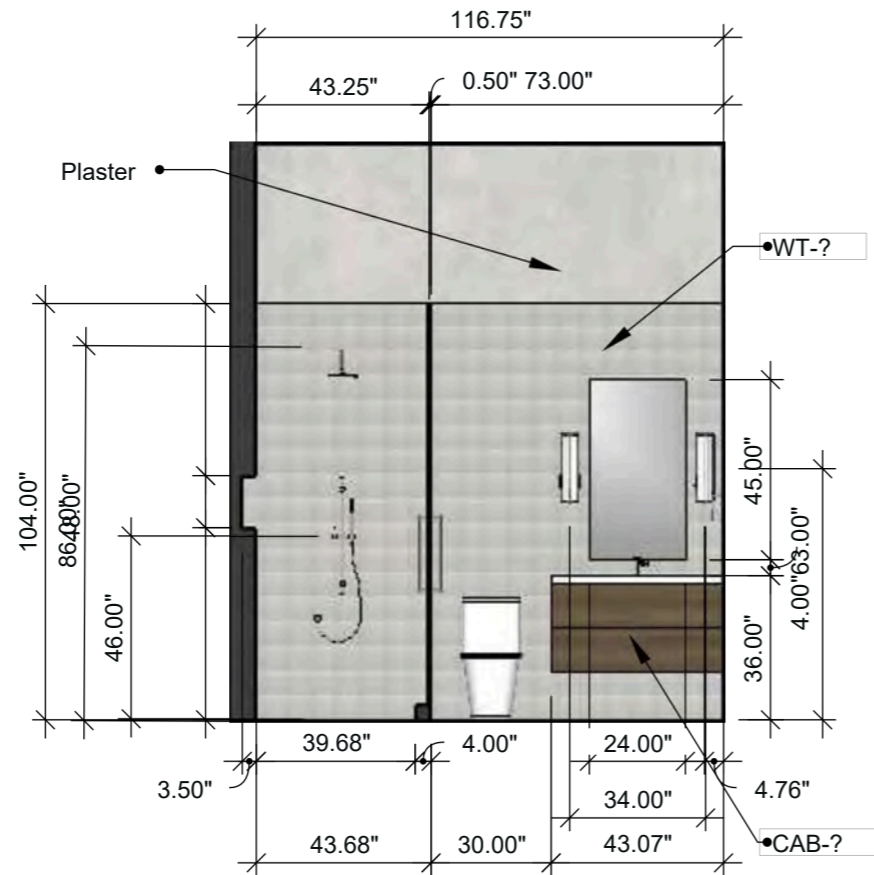

Outdoor Bath Elevation 1
SCALE: 1/4" = 1'-0" (1:48)

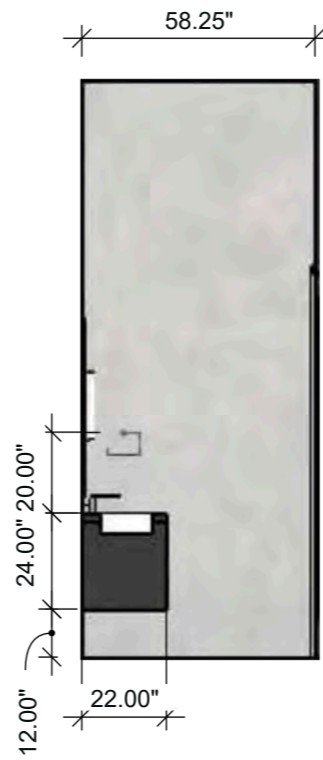

Outdoor Bath Elevation 2
SCALE: 1/4" = 1'-0" (1:48)

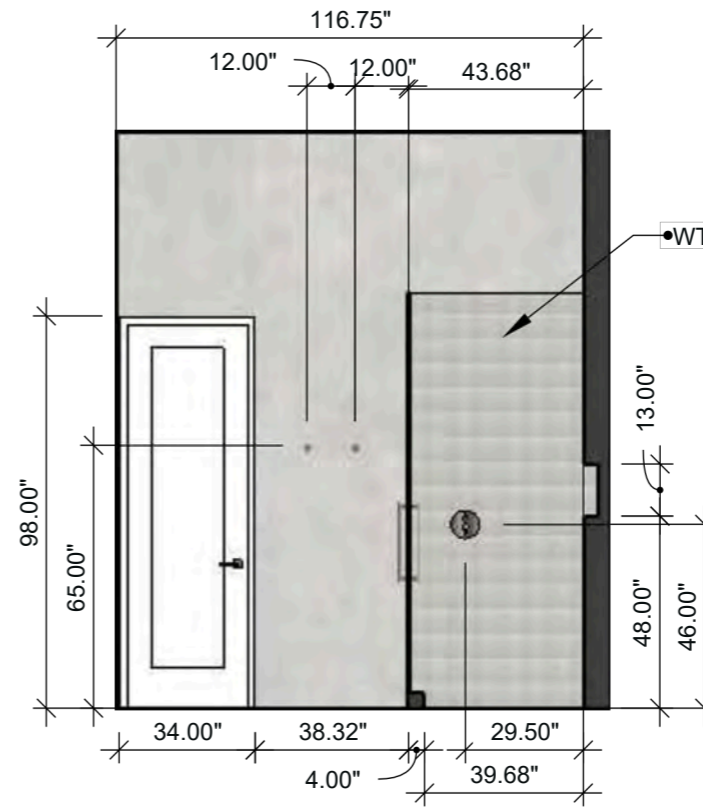

Outdoor Bath Elevation 3
SCALE: 1/4" = 1'-0" (1:48)

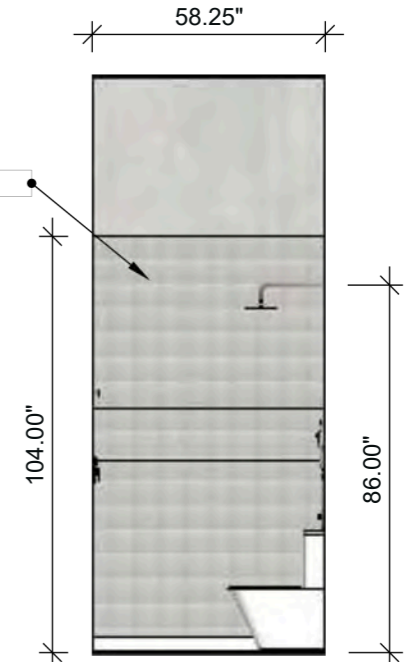

Outdoor Bath Elevation 4
SCALE: 1/4" = 1'-0" (1:48)

OUTDOOR BATH ELEVATIONS

Outdoor Kitchen

MATERIALS

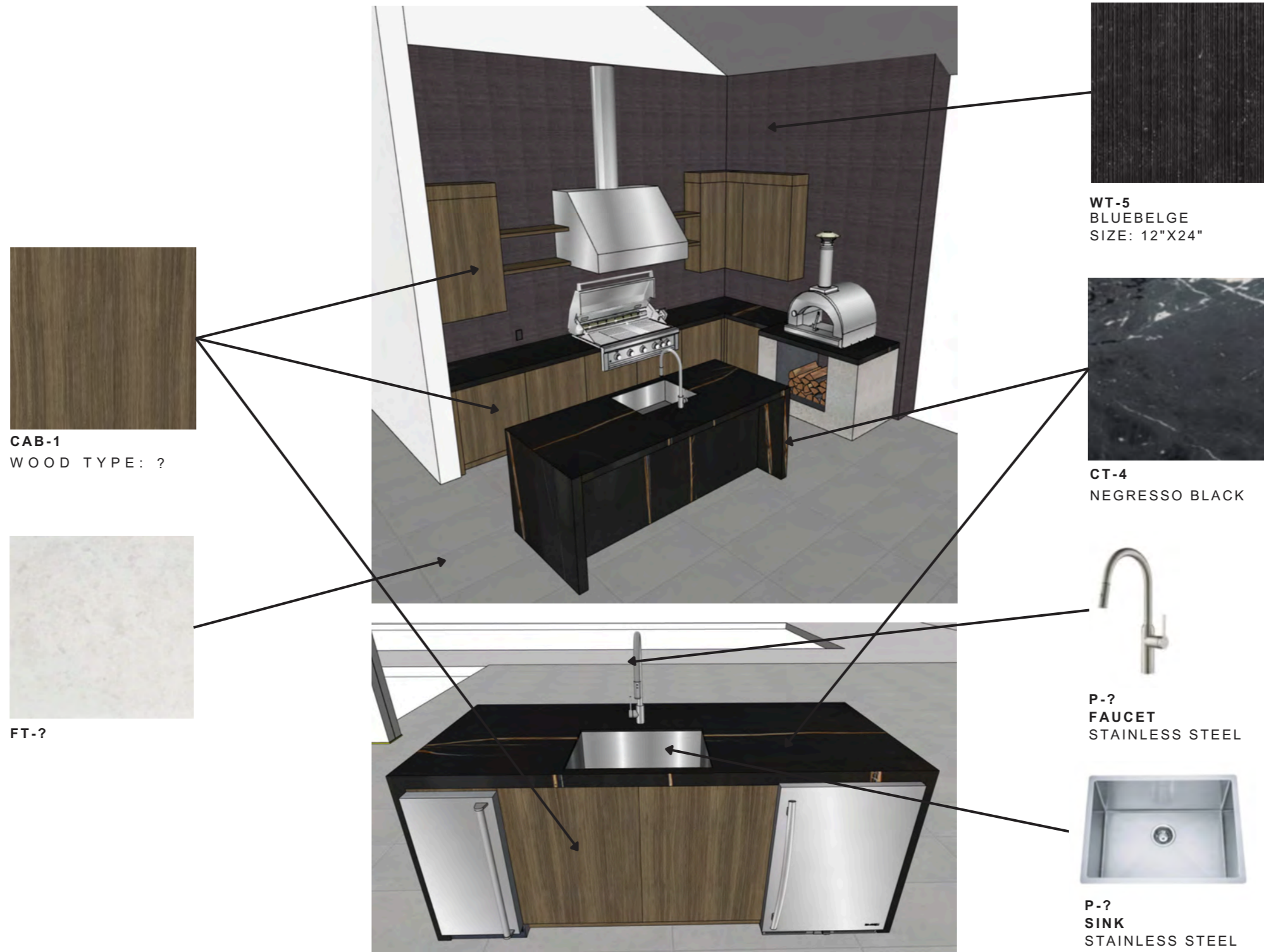



ELYSSA CONTARDO DESIGNS
 P// 760.579.8113
 ELYSSA@ELYSSACONTARDO.COM

GENERAL NOTES:
 WRITTEN DIMENSIONS SHALL TAKE PRECEDENCE OVER SCALED DIMENSIONS AND SHALL BE VERIFIED ON JOB SITE. ANY DISCREPANCY SHALL BE BROUGHT TO THE ATTENTION OF ELYSSA CONTARDO DESIGNS FOR CLARIFICATION BEFORE PROCEEDING WITH WORK. DRAWINGS TO BE USED IN CONNECTION WITH ARCHITECTURAL DRAWINGS. ALL DIMENSIONS ARE BASED ON ARCHITECTURAL DRAWINGS. AS BUILT CONDITIONS MAY VARY.

DRAWING:
 PROJECT:
 2955 HERZOG COURT, PETALUMA, CA

REVISIONS	DESCRIPTION

SQ. FOOTAGE:
 INTERIOR: -
 EXTERIOR: -
 TOTAL: -
 DATE: 1-7-25
 SCALE: NTS
 SHEET: I-13

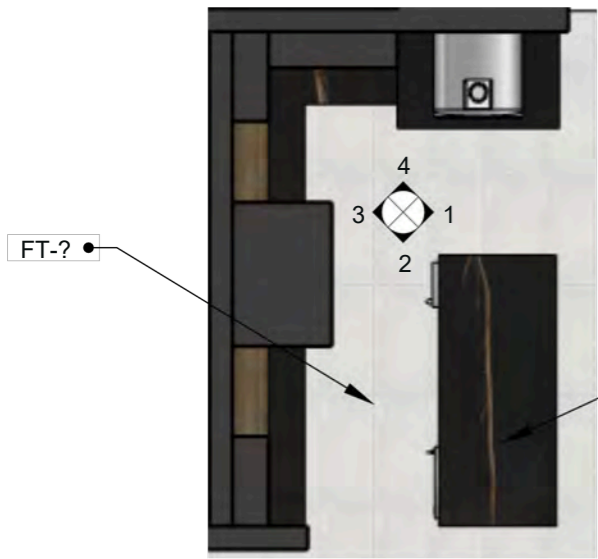

Outdoor Kitchen Top View
 SCALE: 3/16" = 1'-0" (1:64)

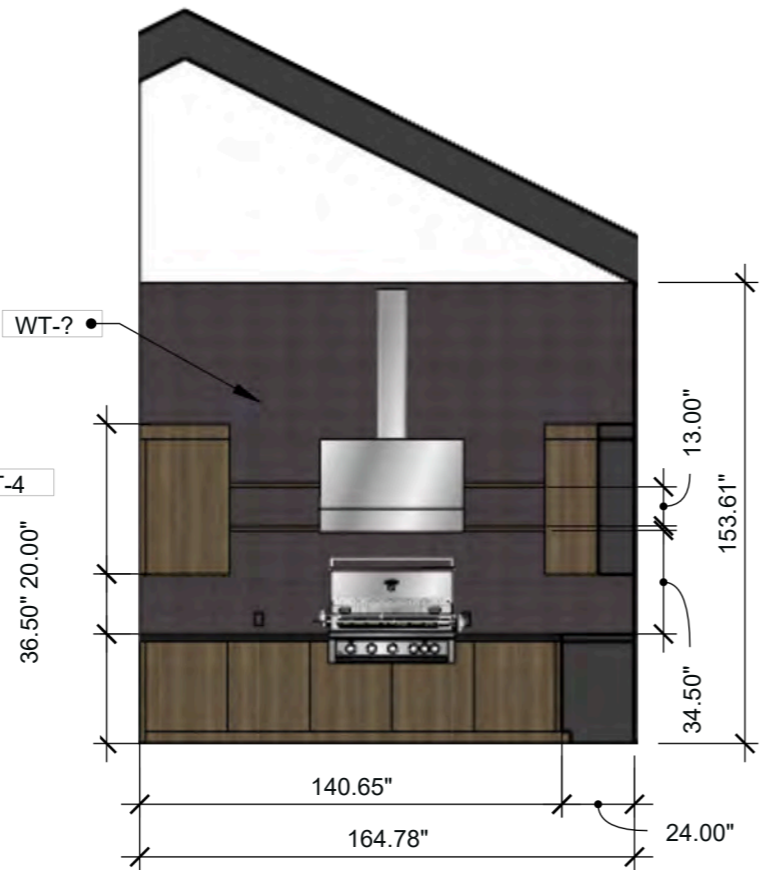

Outdoor Kitchen Elevation 1
 SCALE: 3/16" = 1'-0" (1:64)



Outdoor Kitchen Elevation 1.1
 SCALE: 3/16" = 1'-0" (1:64)

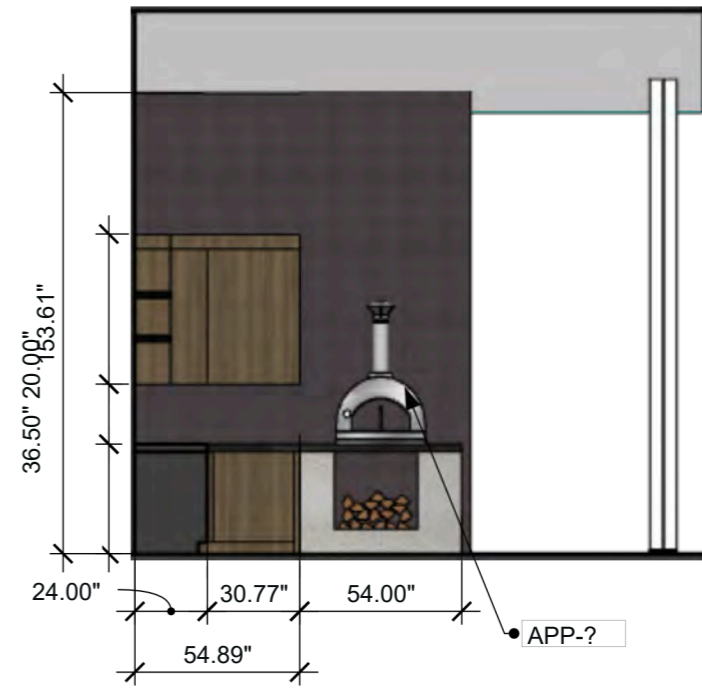

Outdoor Kitchen Elevation 2
 SCALE: 3/16" = 1'-0" (1:64)

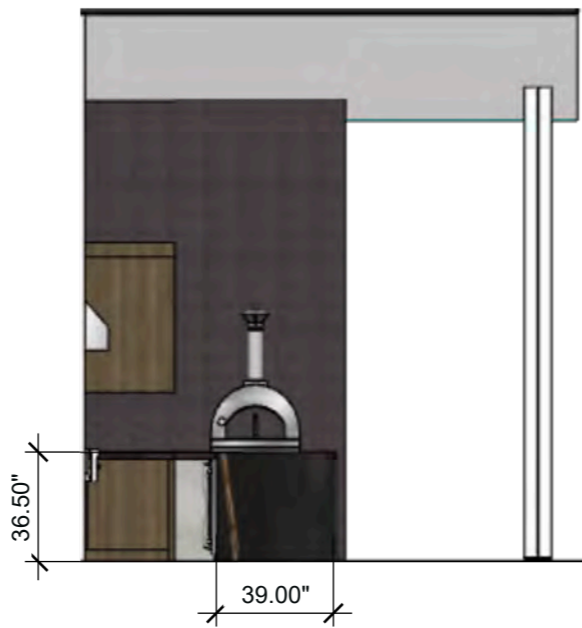

Outdoor Kitchen Elevation 2.1
 SCALE: 3/16" = 1'-0" (1:64)

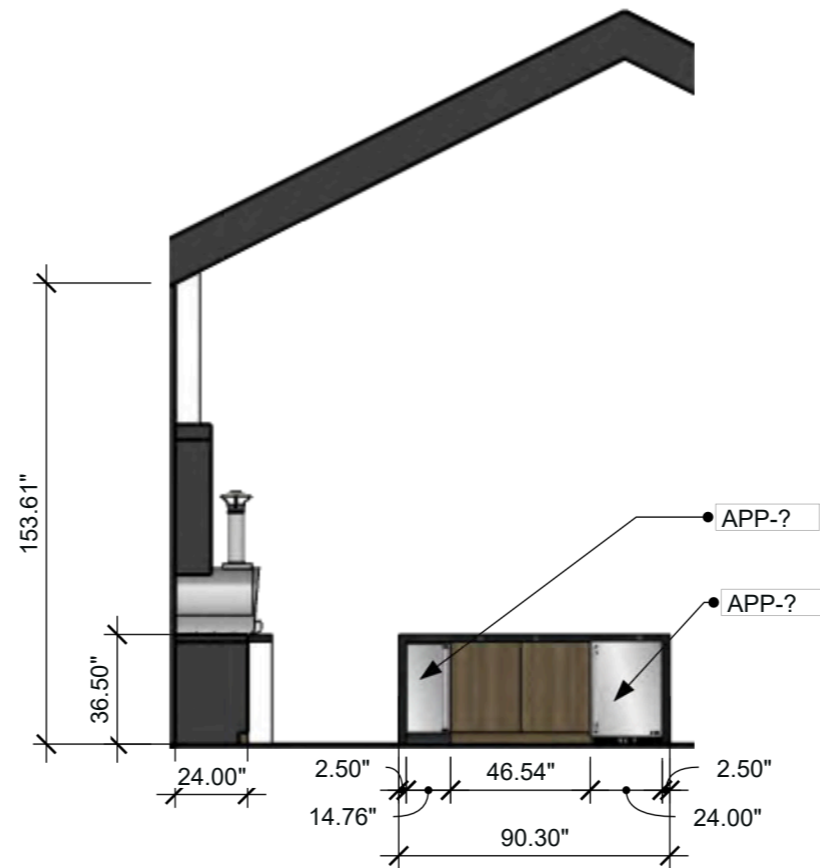

Outdoor Kitchen Elevation 3
 SCALE: 3/16" = 1'-0" (1:64)

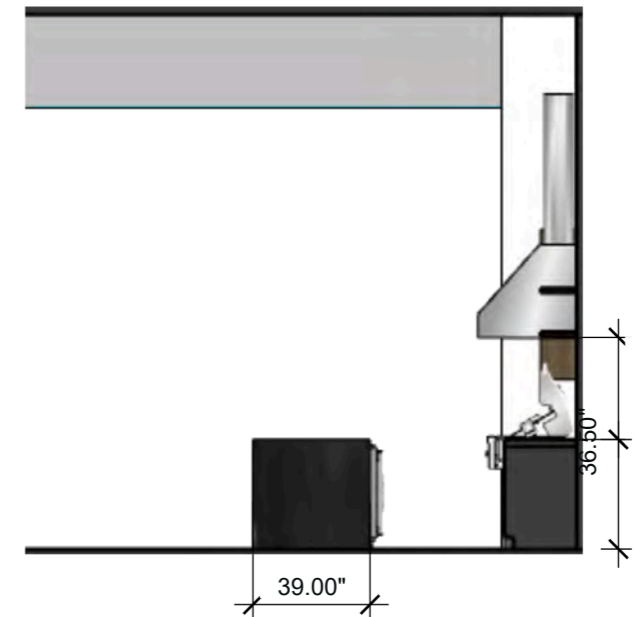

Outdoor Kitchen Elevation 4
 SCALE: 3/16" = 1'-0" (1:64)

OUTDOOR KITCHEN ELEVATIONS



OUTDOOR KITCHEN 3D RENDERING



ELYSSA CONTARDO DESIGNS
P// 760.579.8113
ELYSSA@ELYSSACONTARDO.COM

GENERAL NOTES
WRITTEN DIMENSIONS SHALL TAKE PRECEDENCE OVER SCALED DIMENSIONS AND SHALL BE VERIFIED ON JOB SITE. ANY DISCREPANCY SHALL BE BROUGHT TO THE ATTENTION OF ELYSSA CONTARDO DESIGNS FOR CLARIFICATION BEFORE PROCEEDING WITH WORK. DRAWINGS TO BE USED IN CONJUNCTION WITH ARCHITECT DRAWINGS. SCALE AND DIMENSIONS ARE BASED ON ARCHITECTURAL DRAWINGS AS BUILT CONDITIONS MAY VARY.

DRAWING:
PROJECT:
2955 HERZOG COURT, PETALUMA, CA

REVISIONS	DESCRIPTION

SQ. FOOTAGE:
INTERIOR: -
EXTERIOR: -
TOTAL: -
DATE:
1-7-25
SCALE:
NTS
SHEET:
I-13.1

Wine Room

MATERIALS



CAB-1
WOOD TYPE: ?

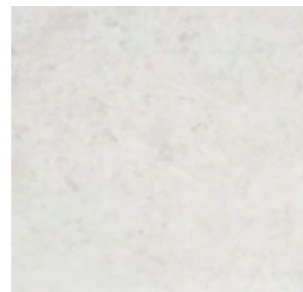

FT-1
ARGARWOOD HONED
SIZE: 18"X36"



PT-1
CEILINGS & WALLS
PORTOLA PAINTS
LIMEWASH OR PLASTER
COLOR: PARLIAMENT

STAIN - 1
DOORS
MATCH TO DESIGNERS SAMPLE



CT-?



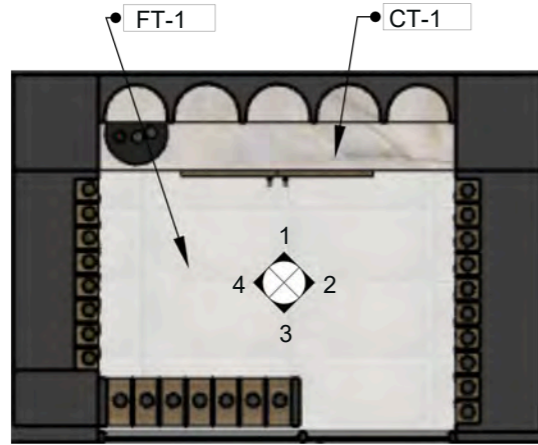

Wine Room Top View
SCALE: 1/4" = 1'-0" (1:48)

5.00"

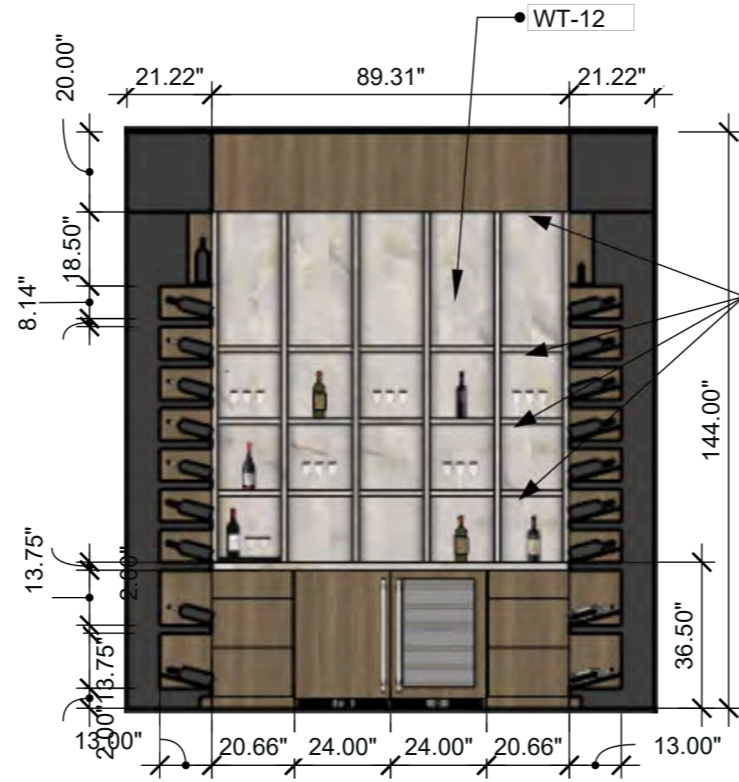

Wine Room Elevation 1
SCALE: 1/4" = 1'-0" (1:48)

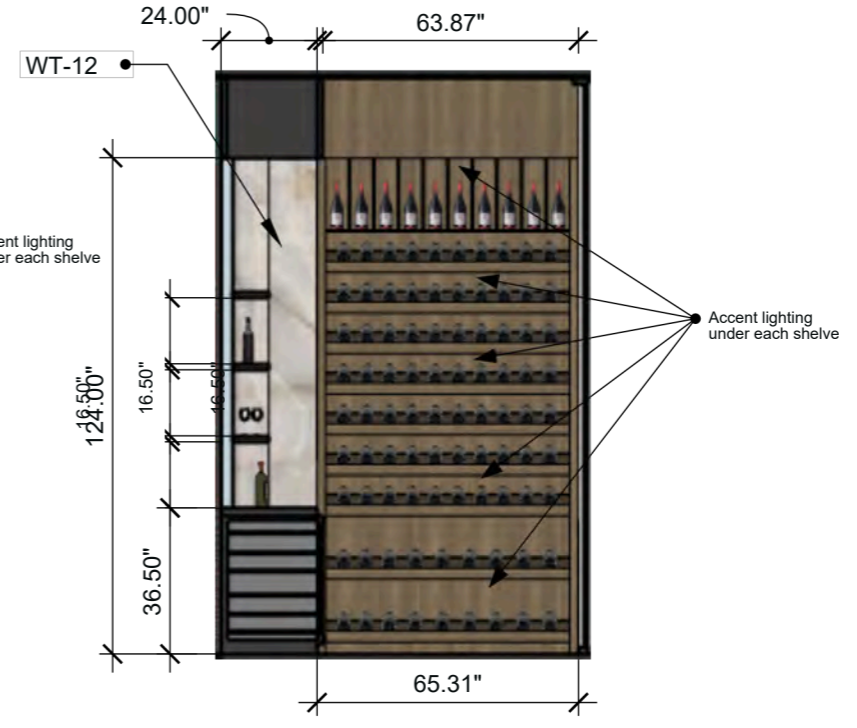

Wine Room Elevation 2
SCALE: 1/4" = 1'-0" (1:48)

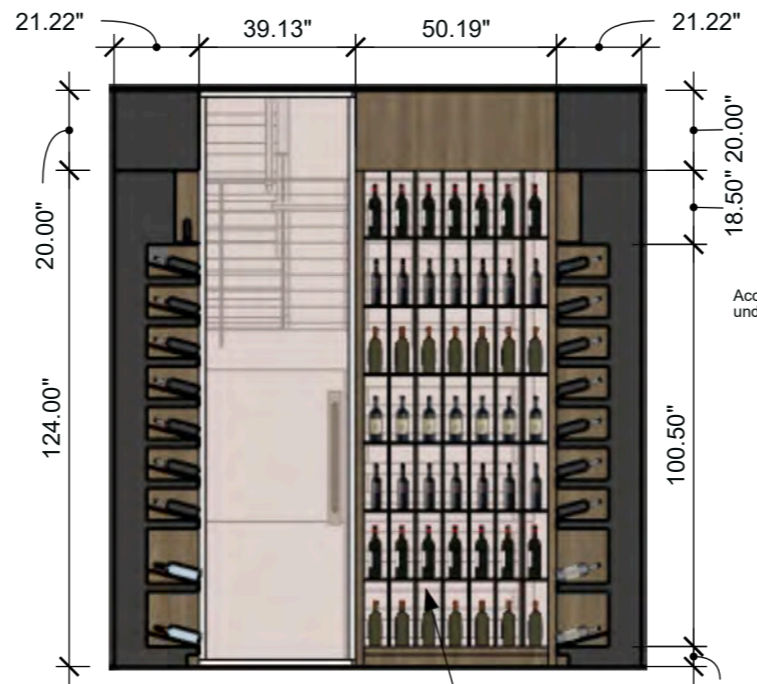

Wine Room Elevation 3
SCALE: 1/4" = 1'-0" (1:48)

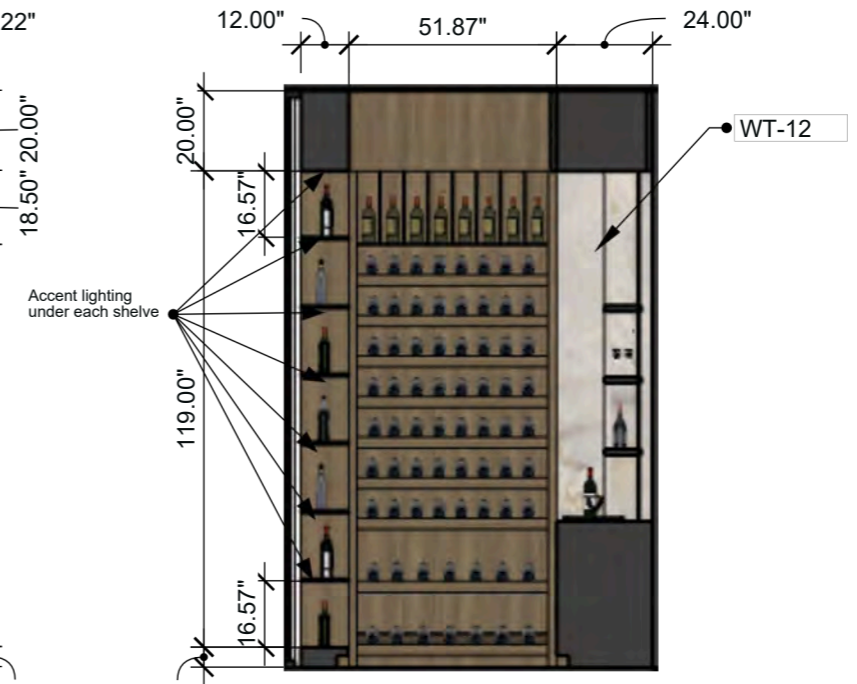

Outdoor Kitchen Elevation 4
SCALE: 1/4" = 1'-0" (1:48)



ELYSSA CONTARDO DESIGNS
P // 760.579.8113
ELYSSA@ELYSSACONTARDO.COM

GENERAL NOTES:
WRITTEN DIMENSIONS SHALL TAKE PRECEDENCE OVER SCALED DIMENSIONS AND SHALL BE VERIFIED ON JOB SITE. ANY DISCREPANCY SHALL BE BROUGHT TO THE ATTENTION OF ELYSSA CONTARDO DESIGNS FOR CLARIFICATION BEFORE PROCEEDING WITH WORK. DRAWINGS TO BE USED IN CONJUNCTION WITH ARCHITECT DRAWINGS. ELEVATION DIMENSIONS ARE BASED ON ARCHITECTURAL DRAWINGS AS BUILT CONDITIONS MAY VARY.

DRAWING: PROJECT: 2955 HERZOG COURT, PETALUMA, CA

REVISIONS	DESCRIPTION

SQ. FOOTAGE:
INTERIOR: -
EXTERIOR: -
TOTAL: -
DATE: 1-7-25
SCALE: NTS
SHEET: I-14

WINE ROOM ELEVATIONS



ELYSSA CONTARDO DESIGNS
P // 760.579.8113
ELYSSA@ELYSSACONTARDO.COM

GENERAL NOTES
WRITTEN DIMENSIONS SHALL TAKE PRECEDENCE OVER SCALED DIMENSIONS AND SHALL BE VERIFIED ON JOB SITE. ANY DISCREPANCY SHALL BE BROUGHT TO THE ATTENTION OF ELYSSA CONTARDO DESIGNS FOR CLARIFICATION BEFORE PROCEEDING WITH WORK. DRAWINGS TO BE USED IN CONJUNCTION WITH ARCHITECT DRAWINGS. ALL DIMENSIONS ARE BASED ON ARCHITECTURAL DRAWINGS. AS BUILT CONDITIONS MAY VARY.

DRAWING:
PROJECT:
2955 HERZOG COURT, PETALUMA, CA

REVISIONS	DESCRIPTION

SQ. FOOTAGE:
INTERIOR: -
EXTERIOR: -
TOTAL: -
DATE:
1-7-25
SCALE:
NTS
SHEET:
I-14.1



WINE ROOM 3D RENDERING

Primary Bedroom Wet Bar

MATERIALS

PT-1
CEILINGS & WALLS
PORTOLA PAINTS
LIMEWASH OR PLASTER
COLOR: PARLIAMENT

STAIN - 1
DOORS
MATCH TO DESIGNERS SAMPLE



P-?
FAUCET
PEWTER
QTY: 1

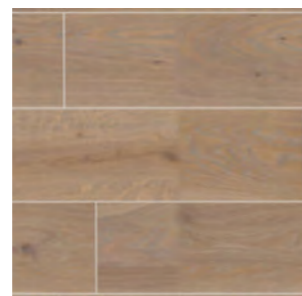

F-1
ENGINEERED WOOD

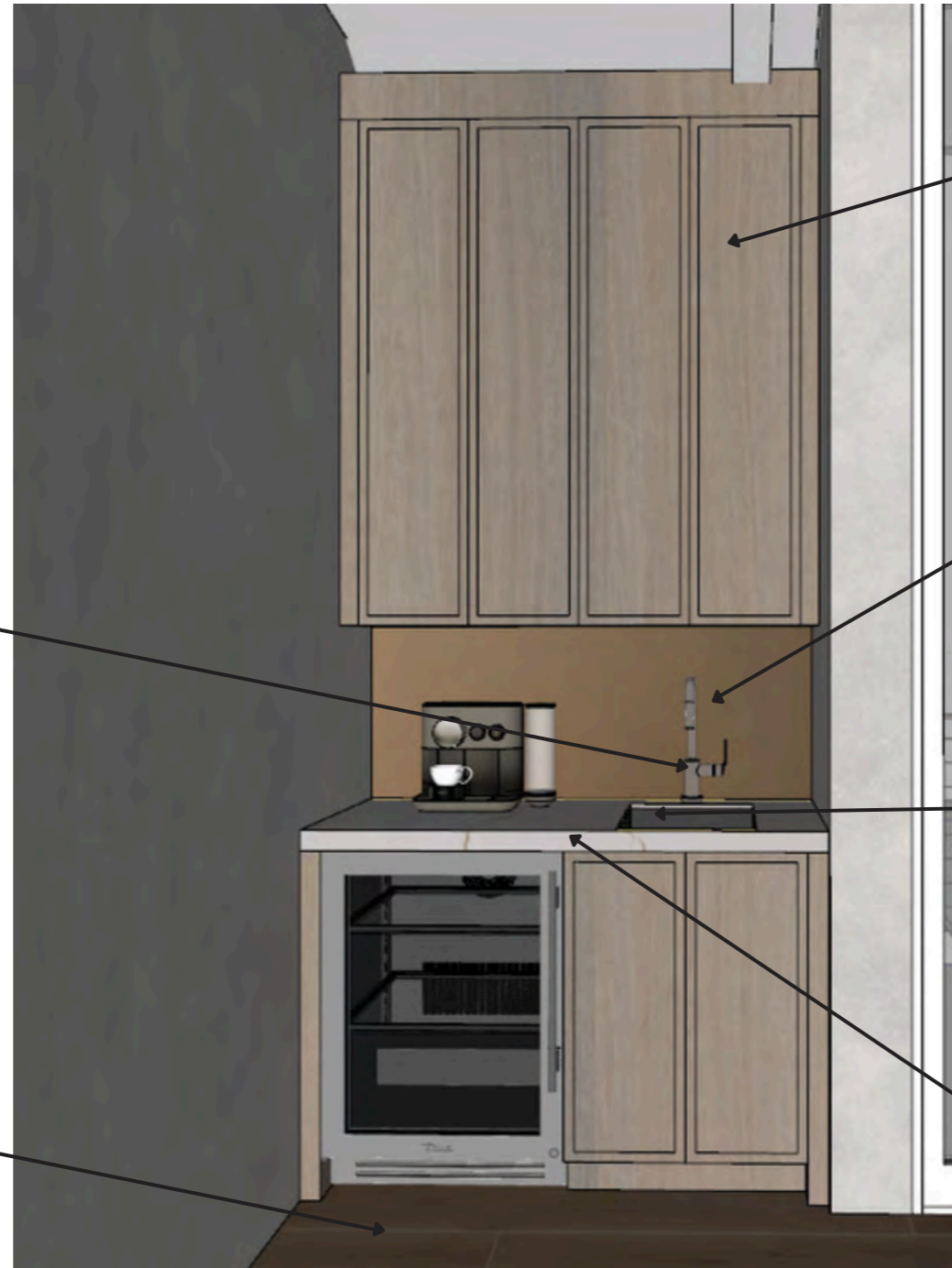

CAB-?
WOOD TYPE: ?



W-4
BRONZE MIRROR



P-?
SINK
COAL BLACK
QTY: 1

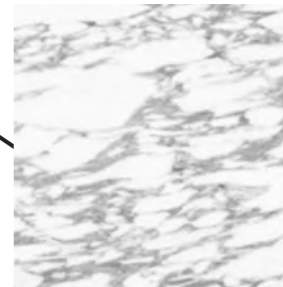

CT-9
CORCHIA MOON FACE
HONED





Primary Bedroom Top View
SCALE: 1/8" = 1'-0" (1:96)



Primary Bedroom Elevation 1
SCALE: 3/16" = 1'-0" (1:64)

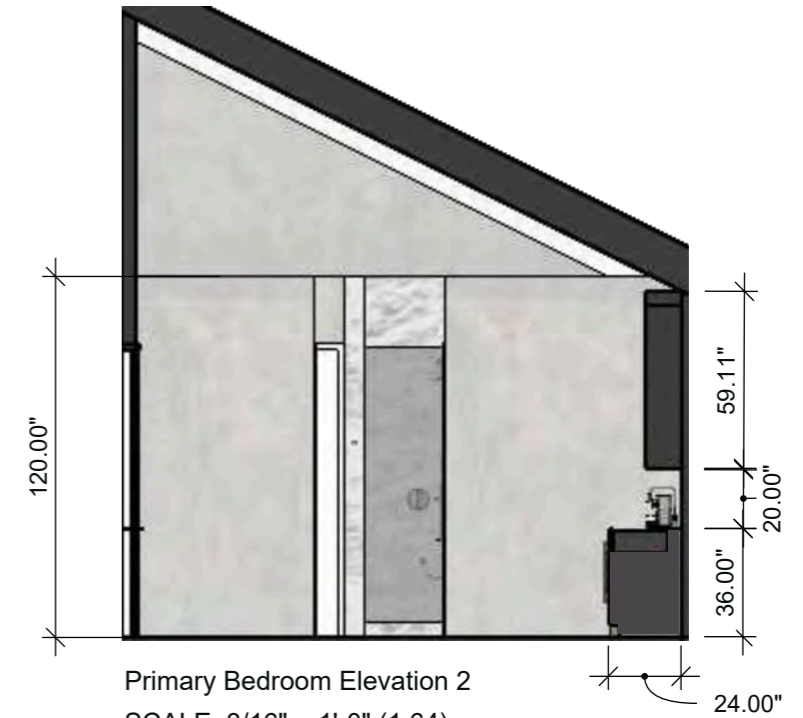

Primary Bedroom Elevation 2
SCALE: 3/16" = 1'-0" (1:64)

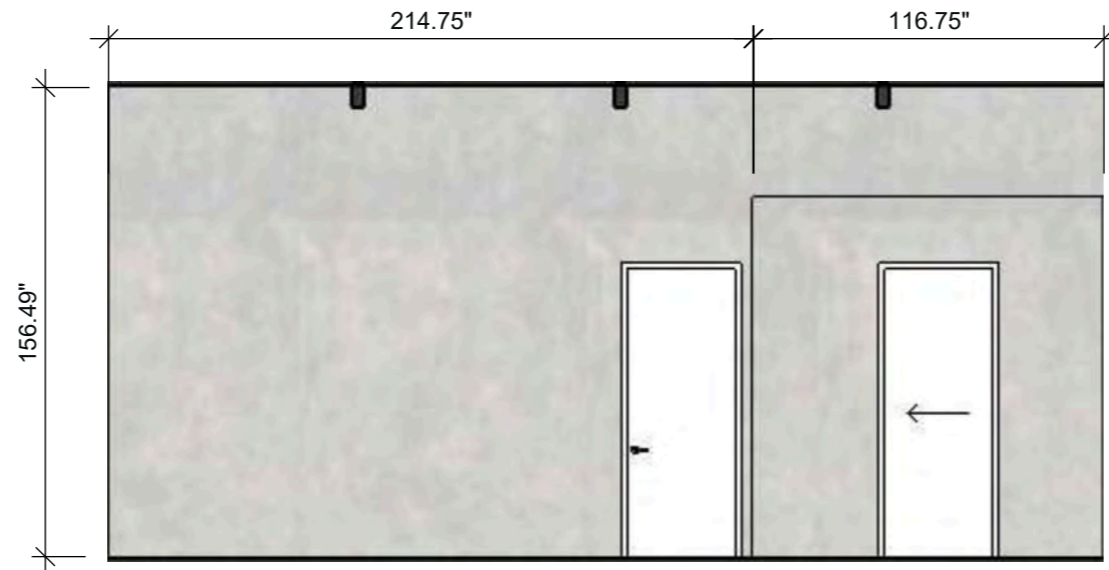

Primary Bedroom Elevation 3
SCALE: 3/16" = 1'-0" (1:64)

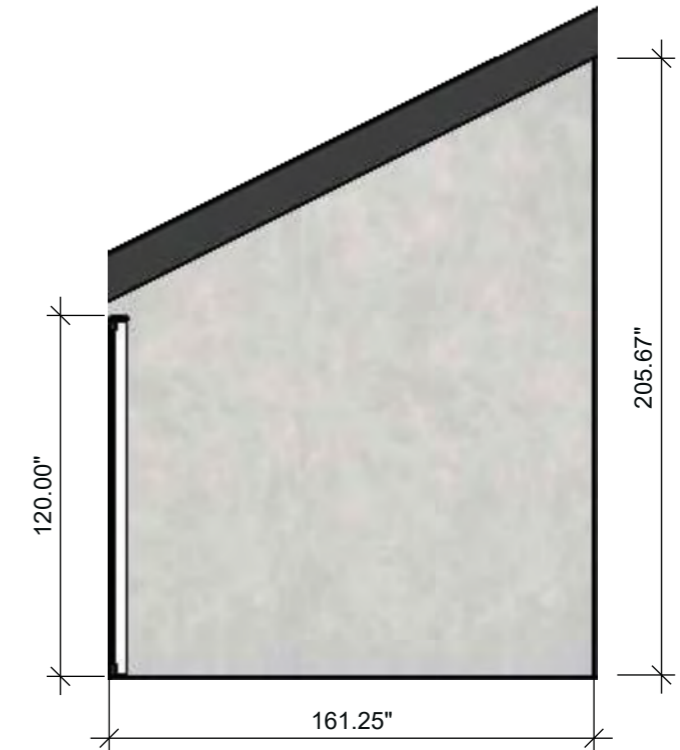

Primary Bedroom Elevation 4
SCALE: 3/16" = 1'-0" (1:64)

PRIMARY BEDROOM ELEVATIONS



ELYSSA CONTARDO DESIGNS
P// 760.579.8113
ELYSSA@ELYSSACONTARDO.COM

GENERAL NOTES
WRITTEN DIMENSIONS SHALL TAKE PRECEDENCE OVER SCALED DIMENSIONS AND SHALL BE VERIFIED ON JOB SITE. ANY DISCREPANCY SHALL BE BROUGHT TO THE ATTENTION OF ELYSSA CONTARDO DESIGNS FOR CLARIFICATION BEFORE PROCEEDING WITH WORK. DRAWINGS TO BE USED IN CONSTRUCTION SHALL CONFORM TO ALL APPLICABLE ARCHITECTURAL STANDARDS AND BUILT CONDITIONS MAY VARY.

DRAWING:
PROJECT:
2955 HERZOG COURT, PETALUMA, CA

REVISIONS	DESCRIPTION

SQ. FOOTAGE:
INTERIOR: -
EXTERIOR: -
TOTAL: -
DATE: 1-7-25
SCALE:
NTS
SHEET:
I-15

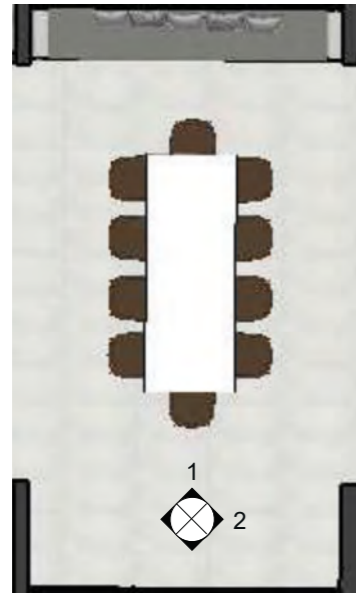

Dining Room Top View
SCALE: 1/8" = 1'-0" (1:96)

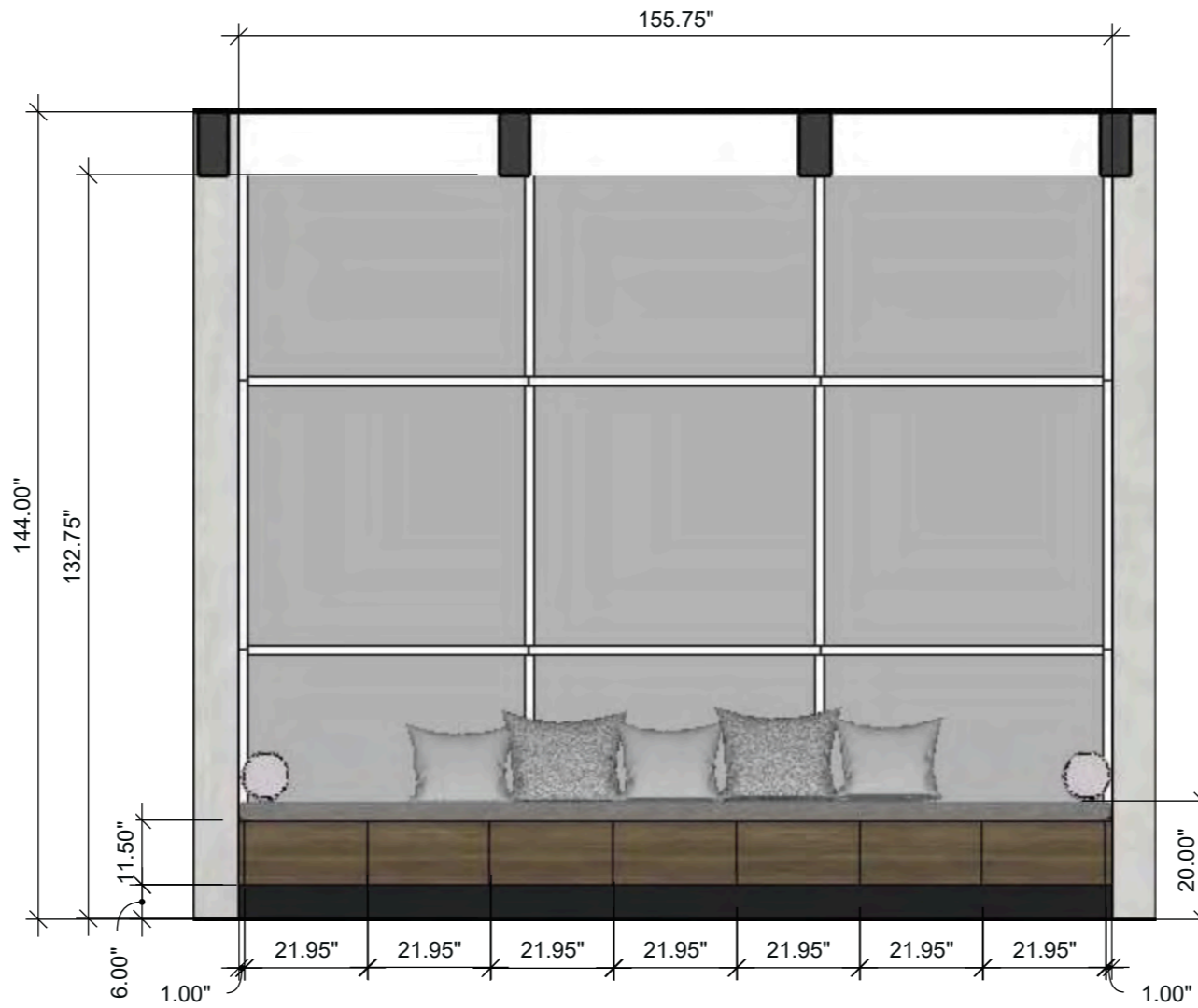

Dining Room Built-in Bench Elevation 1
SCALE: 3/8" = 1'-0" (1:32)



Dining Room Built-in Bench Elevation 2
SCALE: 3/8" = 1'-0" (1:32)



ELYSSA CONTARDO DESIGNS
P// 760.579.8113
ELYSSA@ELYSSACONTARDO.COM

GENERAL NOTES
WRITTEN DIMENSIONS SHALL TAKE PRECEDENCE OVER SCALED DIMENSIONS AND SHALL BE VERIFIED ON JOB SITE. ANY DISCREPANCY SHALL BE BROUGHT TO THE ATTENTION OF ELYSSA CONTARDO DESIGNS FOR CLARIFICATION BEFORE PROCEEDING WITH WORK. DRAWINGS TO BE USED IN CONJUNCTION WITH ARCHITECT DRAWINGS. ALL DIMENSIONS ARE BASED ON ARCHITECTURAL DRAWINGS AS BUILT CONDITIONS MAY VARY.

DRAWING: 2955 HERZOG DRIVE, PETALUMA, CA

REVISIONS	DESCRIPTION

SQ. FOOTAGE:
INTERIOR: -
EXTERIOR: -
TOTAL: -

DATE:
3-28-25
SCALE:
NTS
SHEET:

DINING ROOM BUILT-IN BENCH ELEVATIONS



DINING ROOM BUILT-IN BENCH 3D RENDERINGS



ELYSSA CONTARDO DESIGNS
P // 760.579.8113
ELYSSA@ELYSSACONTARDO.COM

GENERAL NOTES
WRITTEN DIMENSIONS SHALL TAKE PRECEDENCE OVER SCALED DIMENSIONS AND SHALL BE VERIFIED ON JOB SITE. ANY DISCREPANCY SHALL BE BROUGHT TO THE ATTENTION OF ELYSSA CONTARDO DESIGNS FOR CLARIFICATION BEFORE PROCEEDING WITH WORK. DRAWINGS TO BE USED IN CONNECTION WITH ARCHITECT DRAWINGS. ALL DIMENSIONS ARE BASED ON ARCHITECTURAL DRAWINGS. AS-BUILT CONDITIONS MAY VARY.

PROJECT:

DRAWING:

2955 HERZOG DRIVE, PETALUMA, CA

REVISIONS	DESCRIPTION

SQ. FOOTAGE:
INTERIOR: -
EXTERIOR: -
TOTAL: -

DATE:
3-28-25
SCALE:
NTS
SHEET:

GENERAL NOTES
WRITTEN DIMENSIONS SHALL TAKE PRECEDENCE OVER SCALED DIMENSIONS AND SHALL BE VERIFIED ON JOB SITE. ANY DISCREPANCY SHALL BE BROUGHT TO THE ATTENTION OF ELYSSA CONTARDO DESIGNS FOR CLARIFICATION BEFORE PROCEEDING WITH WORK. DRAWINGS TO BE USED IN CONJUNCTION WITH ARCHITECT DIMENSIONS. ALL DIMENSIONS ARE BASED ON ARCHITECTURAL DRAWINGS AND BUILT CONDITIONS MAY VARY.

REVISIONS	DESCRIPTION

SQ. FOOTAGE:
INTERIOR: -
EXTERIOR: -
TOTAL: -

DATE: 3-28-25
SCALE: NTS
SHEET:

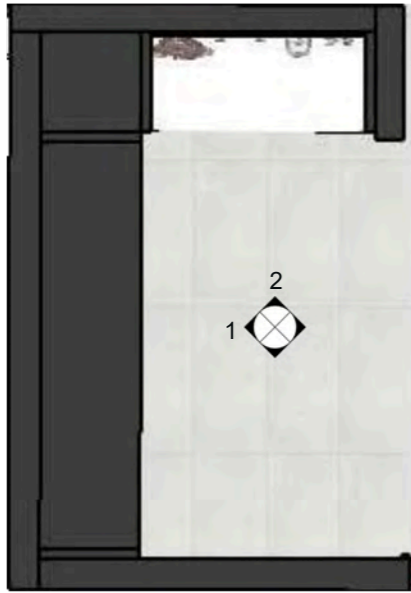

Mudroom Top View
SCALE: 1/4" = 1'-0" (1:48)



Mudroom Elevation 1
SCALE: 3/8" = 1'-0" (1:32)

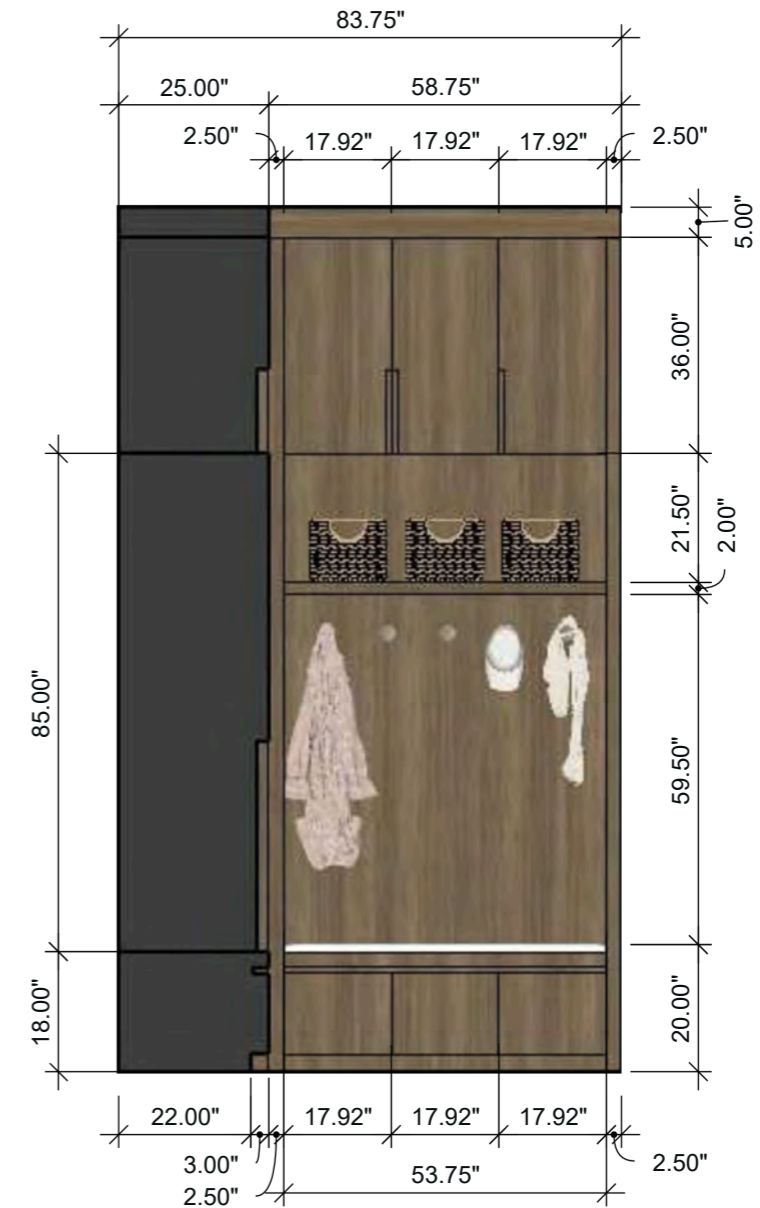

Mudroom Elevation 2
SCALE: 3/8" = 1'-0" (1:32)

PROJECT:

ENTRY MUDROOM ELEVATIONS



ELYSSA CONTARDO DESIGNS
P// 760.579.8113
ELYSSA@ELYSSACONTARDO.COM

GENERAL NOTES
WRITTEN DIMENSIONS SHALL TAKE PRECEDENCE OVER SCALED DIMENSIONS AND SHALL BE VERIFIED ON JOB SITE. ANY DISCREPANCY SHALL BE BROUGHT TO THE ATTENTION OF ELYSSA CONTARDO DESIGNS FOR CLARIFICATION BEFORE PROCEEDING WITH WORK. DRAWINGS TO BE USED IN CONJUNCTION WITH ARCHITECT DRAWINGS. ALL OTHER DIMENSIONS ARE BASED ON ARCHITECTURAL DRAWINGS. AS BUILT CONDITIONS MAY VARY.



PROJECT:

DRAWING:

2955 HERZOG DRIVE, PETALUMA, CA

REVISIONS	DESCRIPTION

SQ. FOOTAGE:
INTERIOR: -
EXTERIOR: -
TOTAL: -

DATE:
3-28-25
SCALE:
NTS
SHEET:

ENTRY MUDROOM 3D RENDERINGS

